



# **DEVELOPMENT PLAN AND WHITEPAPER**

VERSION 1.0.0.0

2018.5



## Preface

The VeChain team and the VeChain blockchain and platform has been running for more than two and half years.

During our journey, we have met many people who share our goals. Our business partners, both enterprises and individuals, dare to explore this new technology with passion, dreams, and strong beliefs. Moreover, we have accumulated experience with use cases from different industries to adjust and resolve any necessary corrections during this process. We will continue defining the right path to take when implementing this “disruptive technology” that will change the world.

Our original vision has never changed. The dream is still the same as before, that is:

**Building a trust-free and distributed business ecosystem platform to enable transparent information flow, efficient collaboration, and high-speed value transfers.**

Nine months have passed since the release of the VeChain ICO. The vision stays the same but our various missions have been reshaped gradually along with the rapid development of the entire blockchain industry.

VeChain aims to be THE PLATFORM to support blockchain-based business applications offering real economic and social value.

After a comprehensive study of existing public blockchain platforms (including Ethereum) and countless discussions and debates with multiple business partners, we identified reasons in which enterprise and large consumer-focused applications are not yet on blockchain. The largest identified hurdles are NOT about the technology, but instead are related to other critical aspects of the blockchain’s operational design.

We’ve identified four key hurdles to enterprise adoption of blockchain.

First, most public blockchains lack a proper **governance model**. Although decentralization is the well-known cornerstone of blockchain technology, it has obvious defects leading to inefficiency and poor capacity to conduct fast iterations. We believe scalability issues relating to blockchain are not linked to technical problems but to consensus concerns of governance. It is hard to imagine a world-wide used “software” or “system” like Bitcoin, with a valuation of more than 140 billion dollars, conduct very few upgrades in the past 10 years. Of course, Satoshi’s original vision was brilliant, and the Bitcoin blockchain functions as originally designed and intended. But as the use cases for blockchain have evolved, and continue to evolve, changes to the features and functions of a blockchain are inevitable. A proper governance system, with transparency and operational efficiency, will enable continual and rapid innovation.

Second, the **economic model** of almost every existing public blockchain directly or indirectly links the transaction costs to the total valuation of the respective blockchain, resulting in unpredictable and unnecessarily high transaction costs. In most public blockchains there exists a paradox: the greater the use of a blockchain, the higher the value of tokens, but additionally the higher the cost to use that blockchain, which discourages use and lowers total network value. No business owners would accept running applications or generally running a new business on

blockchain, or anywhere, at an unstable cost. An additional complication is present. Token holders want the value of a token to increase, and enterprise users want it to be stable and/or low. A proper economic model has to be introduced to the next generation of public blockchains in order to resolve these conflicts.

Third, an ecosystem will require many participants other than just technical blockchain experts. As a matter of fact, more business players than expected care about appropriate solutions other than merely technology. Usually, they expect to see solutions require **combinations of a number of technologies** such as blockchain, IoT, Big Data and A.I. Current blockchain ecosystems also require each business owner to be motivated, deeply involved and innovative to create new business values out of blockchain technology. The current blockchain world lacks those who can connect the technology to business use cases by providing such solutions. Therefore the common infrastructure services natively on blockchain must allow technical and business developers to assemble solutions to add value to their business.

Last but not least, the **capacity to comply with regulation and changes** will be one of the key requirements for any utilized blockchain solutions. This is necessary as regulators and governments follow the massive adoption of blockchain knowledge and understanding by the general public and business owners.

To address all the above, VeChain has created the VeChainThor Blockchain. This innovation represents the next generation of public blockchains, called Blockchain X. It includes the following key features:

- 1) New Governance Model
- 2) New Economic Model
- 3) Regulation and Compliance capabilities
- 4) VeChainThor Mainnet and Matching Infrastructure Services

# Table of Contents

1	Background	9
1.1	Kick-off	9
1.2	The Understanding of Blockchain Technology	11
1.2.1	Synergy and Value Transfer	11
1.2.2	Data Availability and Transparency	12
1.3	The vision of VeChain and the VeChainThor Blockchain	14
1.3.1	Distributed Business Ecosystem	14
1.3.2	The "Blood" in the Distributed Ecosystem – VeChain Token (VET) and VeChain Energy - VeThor (VTHO)	15
1.3.3	VeChain Perspective about Blockchain Technology	17
2	Governance Model and Design	18
2.1.	Principles and Philosophy of Governance Structure	18
2.2	Governance Structure	19
2.3	Stakeholders with Voting Authority	20
2.3.1	Stakeholders	20
2.3.2	Stakeholders, Blockchain Operation nodes and multilayer certification	20
2.3.3	Voting Authority Model	20
2.3.3.1	VET holders (VE)	20
2.3.3.2	Smart Contract Owners (SO)	21
2.3.3.3	Active Authority Masternode holders (AN)	21
2.3.3.4	Aggregation	21
2.3.4	General Voting	22
2.3.4.1	Subject	22
2.3.4.2	Voting authority counting day and voting day	22
2.3.4.3	Voting platform and procedure	22
2.4	The Board of Steering Committee	24
2.4.1	Mission	24
2.4.2	Membership	24
2.4.2.1	Size, Composition and Criteria	24
2.4.2.2	Term, Retirement and Termination	26
2.4.2.3	New Board Nomination and Election	26
2.4.3	Conduct of the Board of Steering Committee Meetings	27
2.4.3.1	Number of Meetings	27
2.4.3.2	Selection of Agenda Items	27
2.4.3.3	Attendance	28
2.4.3.4	Distribution of Materials; Board Presentations	28
2.4.3.5	Attendance of Non-Members	28
2.4.3.6	Minutes	28
2.4.4	Board Compensation	28

2.5 Advisory Board	30
2.5.1 Composition	30
2.5.2 Membership	30
2.6 Functional Committees	31
2.6.1 Committees	31
2.6.2 Functional Committee Meetings	31
2.6.3 Committee Reports to the Board	31
2.6.4 Function Committees	31
2.6.4.1 Technical Committee	31
2.6.4.2 Operational Committee	32
2.6.4.3 Public Relation Committee	32
2.6.4.4 Regulation Committee	33
2.6.4.5 Compensation and Nomination Committee	33
2.7 Communication and Disclosure	34
2.7.1 Communication with the Board	34
2.7.2 Disclosure	34
2.7.3 Ethics and Conflicts of Interest	34
3 Economic Model and Design	35
3.1 Background	35
3.2 Model Design Philosophy	36
3.3 Model Settings	37
3.4 Estimation of Supply and Demand of VTHO	38
3.4.1 Supply of VTHO	38
3.4.2 Demand for VTHO	38
3.4.3 Transaction Cost	39
3.5 Token Price Modelling	40
3.6 Economy Masternodes	41
4 VeChainThor Core	43
4.1 Payment Model	44
4.2 Transaction Model	46
4.2.1 Transaction ID vs Account Nonce	46
4.2.2 Transaction Dependency	47
4.2.3 Transaction-Based Proof of Work	48
4.2.4 Multi-task Transaction	48
4.3 Proof of Authority	50
4.3.1 Protocol in Detail	50
4.3.1.1 When	50
4.3.1.2 Who	51
4.3.1.3 How to choose the trunk?	52
4.3.1.4 System Continuity	52
4.3.2 51% Attack	53

4.3.3 Long Range Attack	53
5 Architecture and Applications Development	54
5.1 Methodology of Development	54
5.2 VeChainThor Architecture	56
5.2.1 Four-layer Technology Stack of VeChainThor Platform	56
5.2.2 VeChainThor Platform Structure	57
5.2.2.1 Blockchain Abstract Layer	57
5.2.2.2 Business Application Abstract Layer	58
5.2.2.3 Architecture Breakdown	59
5.3 More Technical Details	62
5.3.1 VID Generation and Hash Algorithm	62
5.3.2 Storage of VID on Blockchain	62
5.3.3 Digital Ownership on Blockchain	63
5.3.4 Data Hashed Storage (proof of data)	64
5.3.5 Standard API Gateway	65
5.3.6 Service Discovery Protocol (SDP)	66
5.3.7 Micro-Service	67
5.3.8 Hashed Storage Service (HSS)	67
5.4 Blockchain and IoT	69
5.4.1 Challenges of IoT Technology	69
5.4.2 Blockchain and IoT	69
5.4.3 IoT Development in VeChainThor Blockchain	70
5.5 Technical Testing	73
5.6 Technical Roadmap	76
6 Use Cases and Applications	78
6.1 Fashion and Luxury	80
6.2 Food Safety	82
6.2.1 Oversea Liquor Tracking Platform for D.I.G	82
6.2.2 MyStory	83
6.2.3 Cold-Chain Assurance Solution	84
6.3 Automobiles	86
6.3.1 Digital maintenance logs	86
6.3.2 “Green Driving”	86
6.4 Supply Chain	88
6.4.1 Asset Management for Kuehne + Nagel	89
6.4.2 Supply Chain Risk Management with LogSafer	90
6.5 The Agricultural Industry	92
6.6 Government Affairs	93
6.7 This is just the beginning	96
7 VeChain Foundation Economy	97
7.1 Funding Sources	97

7.1.1 Initial Funds and Token Release	97
7.1.2 Digital assets investment	98
7.1.3 Professional Services	98
7.2 Fund Budgeting	99
7.3 Fund Use Restriction	102
7.4 Financial Plan and Implementation Reports	102
7.5 Digital Asset Management	102
7.6 Disclosure	104
7.7 Legal affairs	104
7.8 Exemption clause	104
7.9 Settlement of dispute clause	104
8 Introduction of the Team and Team Members	105
Appendix A: Independence without association with stakeholders	111
Appendix B: Members of the first Board of Steering Committee and Advisory Board	112
Appendix C: References	114



# 1 Background

## 1.1 Kick-off

Everything starts from the white paper released by a mysterious man, known as Satoshi Nakamoto, in October 2008. This white paper, followed by the first genesis block generated on January 3<sup>rd</sup>, 2009, represents the birth of blockchains. The journey started with doubts, speculation, hype and fears, but most importantly the chance that this technology, like any new technology, could change the world. Bitcoin is recognized as Blockchain 1.0.

From 2009 to 2013, even though only a few people devoted themselves to it, there were still innovative trials and explorations in blockchain technology. The general adoption of blockchain to the world was slowly progressing.

The release of the Ethereum white paper in 2014 and go-live in 2015 represents a giant leap in blockchain technology development through the introduction of smart contracts and the associated execution of those contracts through virtual machines. Ethereum's demonstration that blockchain can describe more complicated activities by deploying and running smart contracts has earned it the rightful recognition as Blockchain 2.0.

Ethereum demonstrated that blockchain was no longer an intellectual exercise that had no applicability to the real-world. Suddenly, enterprises and governments began to take notice of the many new use-cases enabled by smart contracts. A well-known article, "Blockchain: The Trust Machine", published in the Economist in October of 2015 started to spread blockchain to the mainstream.

In the following two years, 2016 and 2017, the dominance of Bitcoin dropped from more than 90% to less than 40% of total cryptocurrency market capitalization, rapidly showing the prosperity of ideas, innovations, and developments in blockchain along with more fears, uncertainties, doubts, and speculation.

Today in 2018, the majority of the enterprise world say that "It's 1995 all over again" and that blockchain is going to change the world like the Internet did in the last 25 years, but in a shorter time frame. Despite the growing public enthusiasm for blockchain's potential, there are still very few business applications of major concern running on any existing public blockchain.

VeChain aims to change that forever.

The metaphor of Standing on the Shoulders of Giants expresses the meaning of "discovering truth by building on previous discoveries". VeChainThor humbly stands on the previous discoveries of Ethereum (Blockchain 2.0) and Bitcoin (Blockchain 1.0). Because of them, we have been able to design a complete, holistic blockchain with the governance structure, token economics, regulatory compliance, and community ecosystem to continually and incrementally evolve the blockchain protocol to absorb any innovation and satisfy the needs of the community, investors, enterprise clients, and academic and governmental partners. In this regard, VeChainThor will be Blockchain 3.0, 4.0, 5.0, etc. For this reason, we refer to VeChainThor not as Blockchain 3.0, but as Blockchain X.

Furthermore, due to the expected rate of adoption and forecast of VeChainThor future, we

recognize that VET would primarily be calculated using fractionals in smart payments. With the mainnet launch's token swap, we will conduct a 1:100 coin split to alleviate this concern. At that time, every 1 VET owned will be exchanged for 100. As a result of the coin split, the requirements for VET allocation in all nodes will also increase by a factor of 100. More details can be found in later sections.

## 1.2 The Understanding of Blockchain Technology

### 1.2.1 Synergy and Value Transfer

In the world of traditional business, all kinds of collaborative and business operations as well as the financial industry agree that TRUST is the biggest cost of doing business. Blockchain technology is “The Trust Machine”.

The essence of a blockchain is an Internet protocol and a collection of technologies about trust.

We can define the meaning of blockchain from three dimensions - data, system and application.

From the data point of view, blockchain is a distributed database system that is continuously updated in chronological order. The data can only be added but not tampered with.

From the system point of view, blockchain is a distributed and real-time synchronized system, allowing participants from different parties to create, access and maintain the data through a mechanism for consensus. It makes the entire blockchain network act as a giant computer formed by multiple nodes located everywhere with network connections and full replication of data.

From the application point of view, blockchain is a standard global platform that allows multiple participants to connect at the same time and manage all digital objects, users, and their relative operations with the consent protocol.

The development of information technology and the Internet has made collaboration more efficient and convenient. However, because of concerns regarding trust, the majority of such efficient collaboration exists only within one entity like an enterprise or an organization. When collaboration occurs between different entities, people regularly still use technology from 40 years ago, like e-mail or even fax. Systems integration is actually not as simple as it seems, with various issues concerning data security, business confidentiality, privacy, legal liability and so on.

For example, a typical business collaboration such as a supply chain (as the graphic shows below) includes different participants such as brand, manufacturer, distributor, retailer, consumer, regulator and relative service providers. All the parties manage the same target-product and share the same goal to create product value in different stages. However, due to the lack of sufficient trust, the collaboration is still in a peer-to-peer model and uses traditional tools. As such, largely the data exchange is inefficient and expensive. In such a traditional product life cycle, even if the logistics have been relatively smooth and efficient, the flow of information is often fragmented and the financial support is relatively inefficient.

Blockchain technology can establish a new trust-free sharing business collaboration model (as the graphic shows below). Various parties can ensure the security of data in a convenient and smooth manner. With the support of a more timely and accurate information flow, value transmission can occur simultaneously with other business activities. In this way, each enterprise can increase the utilization rate of cash flows, and greatly improve the efficiency of value transmission in order to support more business development.

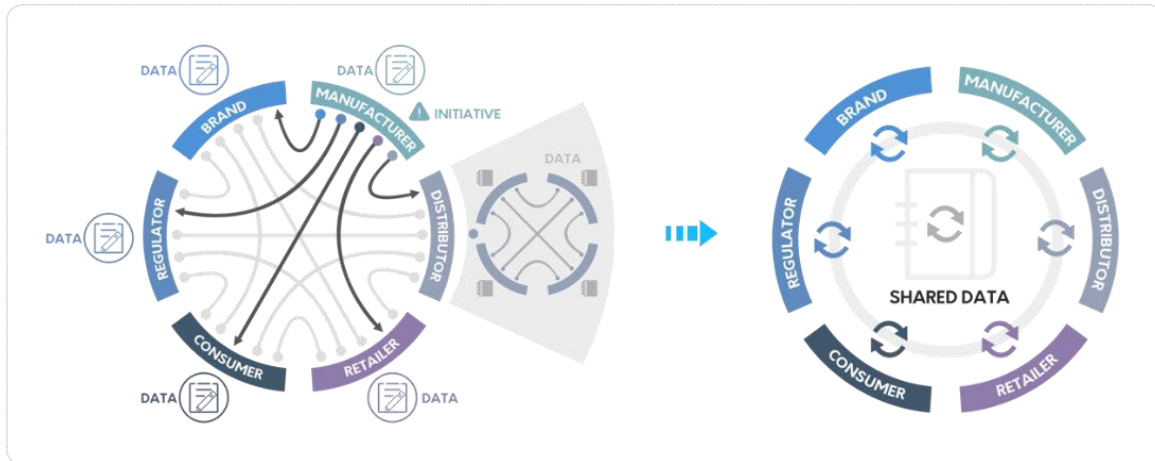

Figure 1.2.1 traditional business collaboration vs distributed business collaboration on blockchain

Looking back through the history of technological development, the first 100 years concerned the technology of physical flows like transportation. The past 30-40 years advanced information flows over the Internet. Now, blockchain is considered and recognized as a technology improving value flows by solving the trust problem. We foresee use cases and applications built on blockchain in the very near future influencing our daily lives, just like the Internet of the present.

### 1.2.2 Data Availability and Transparency

Most enterprises and individuals or, generally speaking, business owners, have three types of data:

- Public data, such as enterprise data that is publicly available on the official website.
- Private data, such as client information, R&D documents, and financial reports for non-listed companies.
- Permitted and shared data, which usually exists between different collaborative partners such as the data from identification, logistics, supply-chain, payment information, after-sale service and so on.

The first two kinds of data are generally easily understood. The interesting part is the third type of data, which usually has to be collected and used as private data by participants.

For example, after a car is sold to the consumer, the accumulating data of the car is fragmented across multiple parties such as service providers, spare parts providers and insurance companies. This data has huge potential value if the fragments can be organized and grouped together. The current reality is that it is difficult and expensive for data users like insurers and banks to collect adequate and accurate data across various data types for future services. Ultimately, these data collection costs are contributing factors to the cost charged to the consumers.

Blockchain technology can break this asymmetric information problem and allow ownership of data to return to and empower its owner. Blockchain creates massive efficiencies in data fungibility and the data extraction, transformation and loading processes when moving data from one distinct environment to another. Through this, blockchain is able to allocate the value of data to different contributors or service providers. For instance, in the automobile scenario described above, the data accumulated during ownership should naturally be owned by the

vehicle owner. A well designed motivation mechanism can be executed by smart contracts to incentivize the data contributors by allocating shared value from cost savings in use cases like insurance programs or automobile trading activities.

Simply put, in the car scenario, the automobile owner should gain the value from authorizing their comprehensive data to an insurer by paying less for the insurance package. They should share this value with the maintenance provider who contributed the data.

Such a blockchain ecosystem, as the signature example of Blockchain use case, is summed up by the following statement of values:

***“You pay the right for what you get and earn the right for what you share.”***

*- Renato Grottola, SVP Global Director M&A and Digital Transformation, DNV GL.*

Blockchain technology allows the chance to create a new and better world by putting data ownership and monetization in the hands of the people who generate that data.

## 1.3 The vision of VeChain and the VeChainThor Blockchain

**The vision of VeChain and the VeChainThor Blockchain is to build a trust-free and distributed business ecosystem platform to enable transparent information flow, efficient collaboration, and high-speed value transfers.**

The vision is manifested through several qualities.

In this ecosystem, the information is relatively **transparent** and symmetrical. A large portion of the source of profit comes from the realization of actual value.

In this ecosystem, individual business parties can greatly reduce the **potential trust cost** between additional parties. This makes business cooperation simpler, more efficient and less expensive. This enables the business to concentrate resources on more advanced technology and better products and services to create more value.

In this ecosystem, each business owner, including enterprises and individuals, can position themselves based on their contribution and value, and obtain a fair reward.

In this ecosystem, all business activities are like individual dots running isolated on the blockchain platform. Through business use cases and innovations new links can be discovered among the dots by maximizing the features of blockchain. This results in a interconnected webbing of dots across the entire ecosystem.

In this ecosystem, the value of growth comes from building links to dots to create grouped value. An example is linking between car company and consumer. From this created value you can find organic growth out of newly discovered links that can carried by high-speed value transmission between these now grouped dots and links. The forms of value created and serviced will be commodities, products, services, assets and funds.

**The VeChainThor Blockchain is the platform to carry out this future ecosystem with robust blockchain core infrastructure, matching infrastructure services, proper governance and economic design, growing community and business engagement.**

### 1.3.1 Distributed Business Ecosystem

In the VeChainThor platform, there are several main types of participants:

#### 1) Business Owners

All kinds of entities such as enterprises, individuals, organizations, departments of governments and regulators that build and run business applications on the VeChainThor Blockchain to provide products and services to users.

#### 2) Application Service Providers

Application service providers help the business owners that do not have the individual adequate

capabilities to build the necessary applicational development and services on the VeChainThor Blockchain.

### 3) Smart Contract Providers

Enterprises, or individuals, that are capable of providing technical services to build and run smart contracts for business owners to develop blockchain applications in a professional, modulated and efficient manner.

### 4) Infrastructure Service Providers

Enterprises and individuals directly participate in the VeChainThor Blockchain and maintain full nodes running and ensuring the integrity of the VeChainThor Blockchain network by generating and verifying blocks. Enterprises and individuals develop and run the specific functional nodes to provide matching infrastructure services for ecosystems like audit services, wallet services, KYC services, voting services, smart contract certification services, Smart Contract Library services and so on.

### 5) VeChain Foundation

The VeChain Foundation (also referred to as “the Foundation”) is the centralized organization formed by the decentralized VeChain community to carry on day to day operations for developing and maintaining the VeChainThor Blockchain, community building and management, business engagement, technical research and design, public services provision, and so on. The VeChain Foundation is responsible for organizing and representing the entire VeChain community and for setting up the Steering Committee with seven seats, which could expand depending on the stage of development, to lead the core team of VeChain.

### 6) VeChain Community

The VeChain community is formed by all entities who are willing to participate and contribute to the development of the VeChainThor ecosystem, rewarded accordingly, and categorized by different level of token holding as below after 1:100 token split when mainnet launches:

- Mjolnir (15,000,000 VET) and Mjolnir X Node (15,600,000 VET)
- Thunder (5,000,000 VET) and Thunder X Node (5,600,000 VET)
- Strength (1,000,000) and Strength X Node (1,600,000 VET)
- VeThor X Node (600,000 VET)

And normal token holders or application users.

## **1.3.2 The "Blood" in the Distributed Ecosystem – VeChain Token (VET) and VeChain Energy - VeThor (VTHO)**

If the entire distributed business ecosystem is considered as an organic body, then the blockchain infrastructure is the skeleton, and applications and services are the muscles and organs. Such a body needs the circulation of the blood, and the blood corresponds to the VeChain tokens – VeChain Token (VET) and VeChainThor Energy a.k.a VeThor (VTHO), carrying the value transfers and executing transactions on the VeChainThor Blockchain network.

VeChain Token (VET) is the “Smart Money” or “Smart Value” in VeChainThor Ecosystem which is programmable and executable in the smart contracts to carry on value transferring along with commercial activities running on the VeChainThor Blockchain. Besides that, VeChain Token (VET) can be discovered as a key element to build up the links among dots in the ecosystem.

VeChain Foundation has distributed more than 70% of VeChain Tokens, including a portion of burnt tokens (in total 132,837,655.34 ERC20 VET) during the refunding process, to the community through different processes including private sale, public sale, promotions, business collaborations, marketing activities, research programs and so on. The VeChain Foundation will continuously and progressively distribute VeChain Tokens to the community through various activities in the coming years.

Meanwhile, VeThor is the energy or the cost of carrying on the payment transactions and smart contract transactions. VeThor is generated from VeChain Tokens over time. More details will be elaborated in the Economic Model section below.

Of course, such development of the ecosystem will go through different stages, and be flexible to open possibilities. A better fusion with the traditional business world will help the transformation of traditional commercial activities. After businesses discover the new business model, they will progressively form a distributed business ecosystem. This will require commitment, innovation and contributions from all participants in the community whether enterprises, individuals, business owners or service providers.

VeChain will support, sponsor and motivate the outstanding business and technical partners to join us together on this journey of creation and changing the world by leveraging best practices in the various industries to help the right people to do what they do best.

In accordance with our experiences in bringing blockchain technology down to earth in the past two years, we have summed up the following steps in developing blockchain applications:

- 1) Identify the most promising breakthrough applications in each industry with the leading strategic players;
- 2) Use cases should be focused on real problem solving, or new value creation;
- 3) Business scenarios usually require many participants, and space for expansion to more;
- 4) Targeted players and targeted use cases have considerable influence over one or more industries; and
- 5) The possibility of discovering links between isolated dots.

In this development, the tactics need to expand both horizontally and vertically:

- 1) Horizontally, replicate the best practices to more, similar use cases;
- 2) Vertically, connect more players to a developed use case.

More participants will bring more extensive collaboration, more efficient value flow, and better chances to create a new coupling business model, and eventually build the distributed business



ecosystem in a progressive way.

### 1.3.3 VeChain Perspective about Blockchain Technology

It has been proven so many times through history that the development of any new technology usually will go through the following important stages:

- 1) The first stage is the **technical barriers** in which the differentiating factor is whether an entity is capable of using the new technology or not;
- 2) The second stage is the **business barriers**. At this stage, the development of technology has been advancing significantly, with the attraction of social resources to this technology, with talent transferring from other fields to join related professions. More technical theories and skills are shared, and technical barriers become increasingly blurred. The quality of delivery of products and services through this technology becomes prominent instead. The capability of transferring technology to commercial applications and business value, rather than merely technological capability, is the key;
- 3) The third stage is the one with **the barriers of scale**. At this stage, the snowball effect is quite obvious, and the advantage of being able to upscale becomes more and more significant. In this stage more business and social activities, more participants and players, as well as the development of more applications leads to faster growth of ecosystem;
- 4) The fourth stage is **the subdividing phase**. At this stage, the technology is now in use on an industrial scale, and its pattern is basically formed. New breakthroughs are discovered through the division of individual fields with more concentrated resources and efforts pushing the limit of efficiency and value in products and services;
- 5) The fifth stage, **the birth of a new technology creates a new cycle**. When the ultimate limit has been reached within the current technology, a new technology will be born to disrupt the current system and initialize a new cycle.

Generally, blockchain technology will not be exceptional to this “routine”.

As of today, blockchain technology still has significant progress outstanding with space for improvement. By this standard we have entered into the **early moments of the second stage**.

Therefore, this Development Plan not only includes the algorithms and technical details required by a Whitepaper, but more importantly, also focuses on the concept and design of the business ecosystem, and the technical support necessary for further development.

We have been and will be humble about the importance and development of blockchain technology and other matters. We have created the necessary good start to accomplish the tasks by providing a comprehensive core to blockchain technology, diversified technical teams with IoT and AI experts, and an iteration mechanism driven by business applications.

## 2 Governance Model and Design

Even though decentralization is the cornerstone of blockchain technology, complete decentralization has been proven to have obvious defects in every applied method, including Bitcoin and Ethereum. Although these projects kicked off with idealized decentralization designs, at this time of publication, they have naturally and progressively become more centralized through large wallets holding a significant portion of tokens, major manufacturers of Bitcoin mining machines, mining pools with large share of total hash power, leading wallet service providers, the biggest influencers in the community and so on. Idealized decentralization is Utopia even to the crypto and blockchain world.

We believe in the balance of decentralization and centralization on which VeChainThor platform's governance is designed. The balance of the platform varies and adapts to the different stages of development in the blockchain technology and ecosystem. VeChain aims to build up a governance model with continuous iterations along with progress of development.

The following Governance Principles and Charters are adopted by the VeChain Foundation to serve as a flexible framework to assist the Board of Steering Committee (referred to as, the "Board" or "SC") in the exercise of its responsibilities. These Governance Principles reflect the Board's commitment to monitor the fairness and effectiveness of policy and decision making for the Foundation. These governance principles should be interpreted in the context of all applicable laws, VeChain Foundation charter documents and other governing legal documents. These governance principles are subject to modification from time to time by the Board.

### 2.1. Principles and Philosophy of Governance Structure

The governance structure and principles are designed for visibility, inclusiveness, transparency, flexibility and efficiency. They are designed to facilitate the development, innovation, coordination and advancement of the VeChainThor Blockchain ecosystem.

## 2.2 Governance Structure

The VeChain Foundation is a nonprofit entity, committed to the development, governance and advancement of the VeChain Platforms ecosystem. The decentralized operating mechanism of the blockchain technology grants the Foundation a unique governance structure. The diagram below provides a stylized view of the Foundation’s current governance structure.

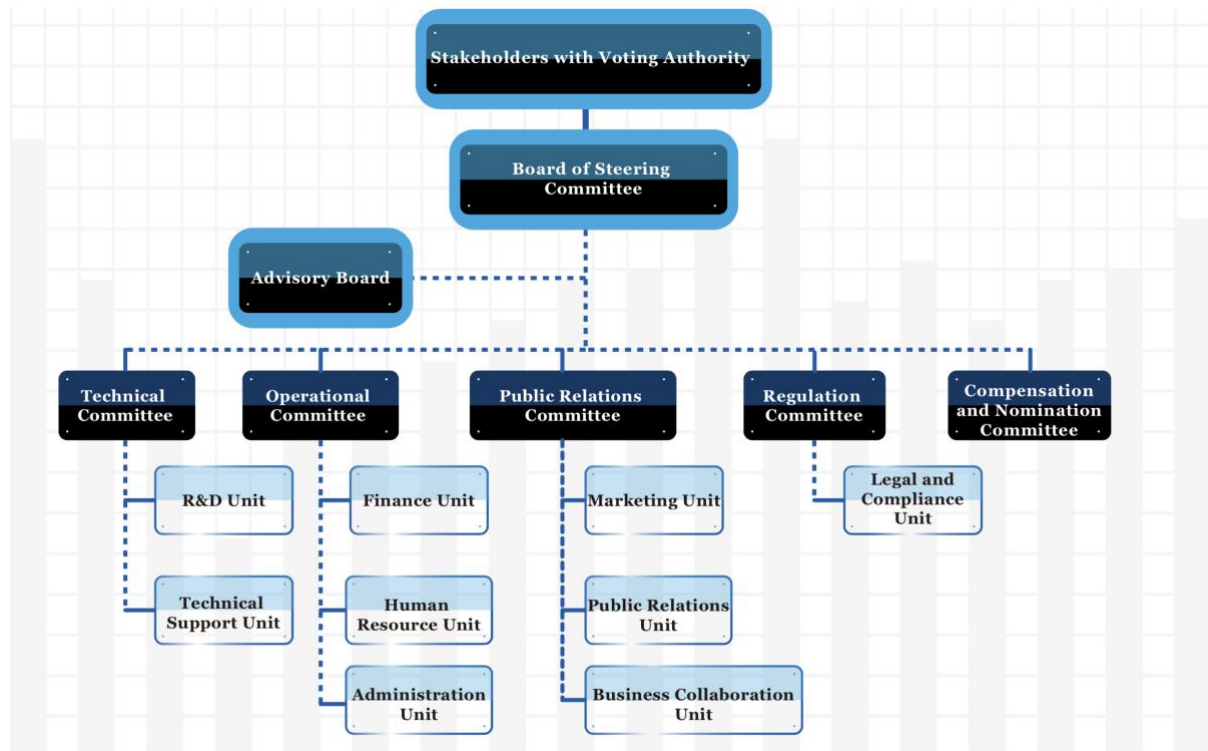

Figure 2.2.1 VeChain Foundation Governance Structure

The Board of Steering Committee is the governing body of the VeChain Foundation. It is selected by identifiable stakeholders with VET Voting Authority. The Steering Committee lays out the critical strategies and selects functional committee chairs to oversee the operational units of the Foundation.

## 2.3 Stakeholders with Voting Authority

### 2.3.1 Stakeholders

In the VeChainThor Platform, the stakeholders are the VET holders and some of them have specific roles such as Smart Contract Owners and Authority Masternode holders. Each of the stakeholders hold voting rights calculated by the voting authority model. The stakeholders can be individuals, corporations, government agencies, non-profit entities and other institutions with a valid legal status. The stakeholder voting mechanism ensures the inclusiveness of all designated stakeholders in the VeChainThor Blockchain ecosystem.

### 2.3.2 Stakeholders, Blockchain Operation nodes and multilayer certification

The following table summarizes the minimum VET holding requirement for each category of stakeholder and their corresponding voting authority (after mainnet launch and 1:100 token split).

	<b>Minimum VET Requirement</b>	<b>Stakeholders with Voting Authority</b>	<b>Voting Authority</b>
<b>1</b>	1,000,000	VET holders without KYC ( <b>VEOK</b> )	20%
<b>2</b>	1,000,000	VET holders with KYC ( <b>VEK</b> )	30%
<b>3</b>	5,000,000	Individual Smart Contract Owner ( <b>SO-I</b> )	20%
<b>4</b>	15,000,000	Enterprise Smart Contract Owner ( <b>SO-E</b> )	
<b>5</b>	25,000,000	Individual Authority Masternode Holder ( <b>AN-I</b> )	30%
<b>6</b>	25,000,000	Enterprise Authority Masternode Holder ( <b>AN-E</b> )	

Besides the minimum VET holding requirement, the stakeholders need to apply for their status in the VeChain portal and submit the required information for verification except for VEOK. VET holders who pass the KYC verification on the VeChain portal will be assigned with a VeVID, which allows them to apply for the Smart Contract Owner or Authority Masternode holder status. There are 101 active Authority Masternode holders on the VeChainThor platform. The votes of Authority Masternode holders on the waitlist do not count towards the voting authority in this category.

Note: Detailed application and verification requirements will be released with the launch of VeChain portal.

### 2.3.3 Voting Authority Model

#### 2.3.3.1 VET holders (VE)

##### 1a. VET holders without KYC (VEOK)

Each VET holder account without KYC who has more than 1,000,000 VET in the account at the voting authority counting date has 1 vote;

The total voting authority for VET holders without KYC (VEOK) accounts for  $\omega_{VEOK} = 20\%$  of

overall voting authority.

#### 1b. VET holders with KYC (VEK)

Each VET holder with KYC verification who has more than 1,000,000 VET in their account at the voting authority counting date has 1 vote;

The total voting authority for VET holders with KYC (VEK) accounts for  $\omega_{VEK} = 30\%$  of overall voting authority.

#### **2.3.3.2 Smart Contract Owners (SO)**

Each Smart Contract Owner who meets the minimum VET holding requirement (individual 5,000,000 VETs, Enterprise 15,000,000 VETs) at the voting authority counting date has 1 vote.

The total voting authority for Smart Contract Owners (SO) accounts for  $\omega_{SD} = 20\%$  of overall voting authority.

#### **2.3.3.3 Active Authority Masternode holders (AN)**

Each active Authority Masternode Holder holding minimum of 25,000,000 VETs in their account at the voting authority counting date has 1 vote.

The total voting authority for Authority Masternode Holder (AN) accounts for  $\omega_{AN} = 30\%$  of overall voting authority.

#### **2.3.3.4 Aggregation**

The final voting result  $V$  can be computed as:

$$V = \omega_{VEOK}V_{VEOK} + \omega_{VEK}V_{VEK} + \omega_{SO}V_{SO} + \omega_{AN}V_{AN}$$

where  $V_{VEOK}$ ,  $V_{VEK}$ ,  $V_{SO}$  and  $V_{AN}$  stand for the voting results for Groups VEOK, VEK, SO and AN. All the weights satisfy  $\omega_{VEOK} + \omega_{VEK} + \omega_{SO} + \omega_{AN} = 1$  and their values can be adjusted by the Steering Committee when deemed appropriate. The vote of a single address can only be counted towards the category based its highest status. Through this equation an example result for VEOK may be split 14% “Yes” and 6% “No” in a Yes or No vote.

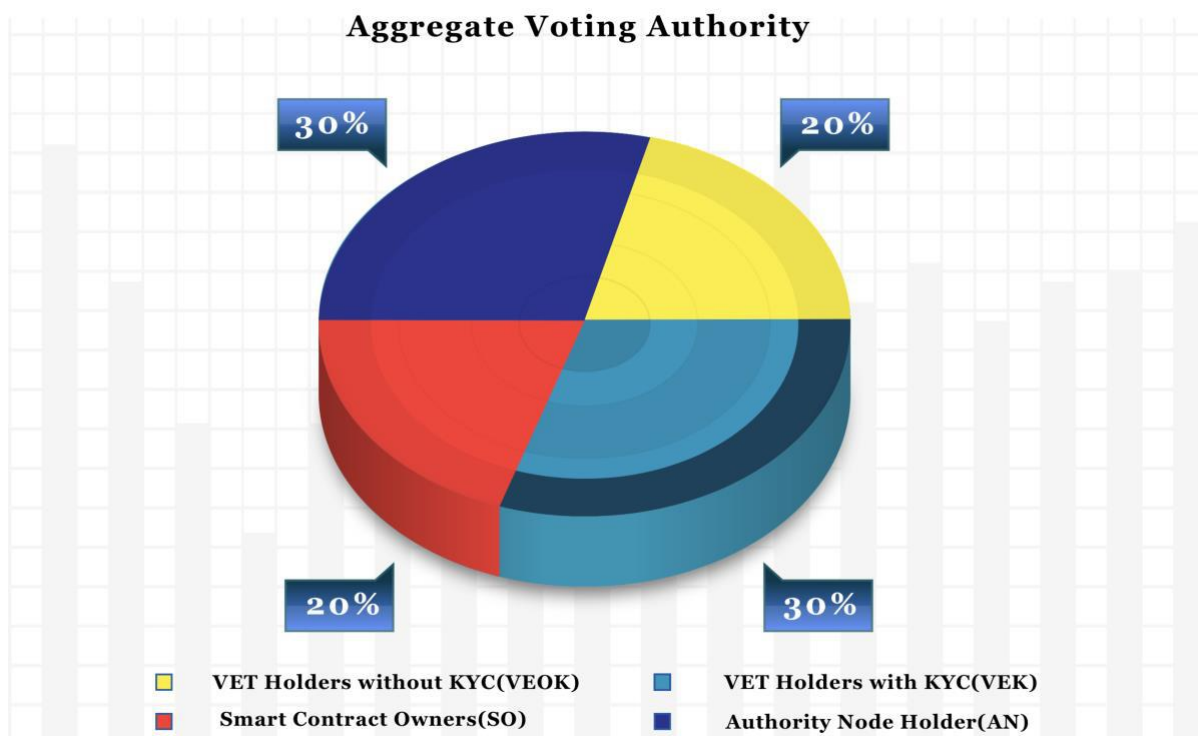

*Figure 2.3.3 VeChain Aggregate Voting Authority*

## 2.3.4 General Voting

### 2.3.4.1 Subject

The following fundamental subjects will be voted by the stakeholders according to their Voting Authority:

- 1) The election of the new Board of Steering Committee;
- 2) The modification of the fundamental consensus mechanism or technical parameters; and
- 3) Other subjects that the Board of Steering Committee deem necessary for general voting.

### 2.3.4.2 Voting authority counting day and voting day

Prior to each vote the Foundation will announce detailed rules such as voting authority counting day, voting day and minimum participation rate. Stakeholders sign up for the upcoming vote on the voting authority counting day, and their VET holding and status will be checked to determine their voting authority. On the voting day, all the stakeholders who signed up for the voting will be able to cast their vote via the VeVote service. Periodical voting events such as the election of steering committee members will be announced at least one month prior to the voting day. For ad-hoc voting events, the Foundation will make the announcement on a case by case basis.

### 2.3.4.3 Voting platform and procedure

The general voting activities shall use the VeVote service, designed to ensure anonymity, accuracy and make manipulation impossible.

For the election of the new board of steering committee, the nomination committee, with assistance from the administrative unit, will announce the nomination list, voting authority counting date and vote date. Candidates with the highest votes gain the membership to the board in accordance with its predetermined size. The nomination committee will announce the election results for the new board of steering committee within 48 hours of ballot end time.

For other subjects listed above, the option(s) receiving the highest voting authority shall be applied. Detailed rules will be announced for each voting activity in advance. The Steering Committee will announce the voting results within 48 hours of ballot end time for ad hoc subjects voting.

In addition, for any vote to be effective, the participant ratio in each voter category or total voters upon sign up and on the voting day needs to be above a predefined threshold based on the voting announcement. Otherwise, the Steering Committee will be entitled to make the decision. Details will be released in the VeVote service.

## 2.4 The Board of Steering Committee

### 2.4.1 Mission

VeChain Foundation is a non-profit entity, committed to the development, governance and advancement of the VeChainThor Blockchain. The Steering Committee is the governing body of the VeChain Foundation. They define the important strategies and select functional committee chairs to oversee the operation of the Foundation. Designed for visibility, inclusiveness, transparency and efficiency, the Foundation will ensure the development, innovation, coordination and advancement of the VeChainThor Blockchain ecosystem.

The Board believes that all committee members represent the balanced interests of the VeChainThor Blockchains multiple stakeholders as a whole.

The Board represents the VeChainThor Blockchain stakeholders' interest in long-term development of the technical infrastructure, business expansion, and VET value enhancement. The Board also recognizes the important role the Foundation plays in the blockchain ecosystem and the importance of providing active governance, designed to ensure the safety and soundness of the operations within the VeChainThor Blockchain. The Board is responsible for establishing the general oversight and framework, including the design of the operating rules of the blockchain, intended to achieve these goals.

The Board's principal functions are to:

- 1) Propose and organize general voting activities for fundamental issues on the VeChainThor Blockchain, including essential adjustments of the consensus mechanism or technical parameters, the election of new Boards of Steering Committee and other subjects that the Board of Steering Committee deems necessary for general voting;
- 2) Review, approve, and monitor the Foundation's major strategic, technical, financial, and business activities;
- 3) Review, modify and approve the governance principles of the Foundation;
- 4) Review, approve and monitor the Foundation's annual budget, financial status including VET holdings, use of proceeds and its major transactions;
- 5) Review, approve and monitor the procedure of nomination and election of the Steering Committee members, functional committee chair and the General Secretary of the Foundation; and
- 6) Review, approve and monitor the operation model of VTHO (operating cost basis of VeChainThor Blockchain) and valuation model of VET including market making policies.

### 2.4.2 Membership

#### 2.4.2.1 Size, Composition and Criteria

**Size of the Steering Committee.** The number of committee members will be determined



from time to time by the Board, ranging between 7, 9, 11 and 13. The nomination sub-committee or any member of the Board of Steering Committee can make recommendations regarding the size of the Board, as appropriate. The size of the Board is designed to ensure it maintains the appropriate expertise, diversity and representation from different stakeholders to effectively oversee the Foundation's operation while maintaining compliance with applicable regulatory requirements.

**Board Composition.** Based on the specific multi-stakeholders' nature of blockchain, Board members are divided into two categories:

- 1) Stakeholder Members are representatives for different stakeholders with voting authorities, defined in section 2.3.1. Stakeholder Members of the Board from any single stakeholder institution, including the VeChain Foundation, end customers, developers, Authority Masternode holders and VET holders. Stakeholder Members that belong to the same entity cannot occupy more than 50% of the committee seats;
- 2) Independent Members are individuals who are not a full-time employee of any of the stakeholders defined in section 2.3.1. At least one seat should be allocated to independent members.

**Board Membership Criteria.** The Board seeks members from diverse professional backgrounds with a broad spectrum of expertise that benefits the strategic guidance of the Foundation. Board members should have the characteristics essential for effectiveness as a member of the Board, including but not limited to:

- 1) Integrity, objectivity, sound judgment and leadership;
- 2) The relevant expertise and experience required to offer advice and guidance to the development strategy of the Foundation;
- 3) The ability to make independent analytical inquiries, collaborate effectively and contribute productively to the Board's discussions and deliberations;
- 4) A commitment to enhancing the long-term value of the VeChainThor Blockchain for stakeholders;
- 5) An understanding of the Foundation and blockchain operation, strategy and challenges;
- 6) The willingness and ability to devote adequate time and effort to Board responsibilities and to serve on Committees at the request of the Board; and
- 7) Is not a Disqualified Person as defined below.

A "Disqualified Person" is any person who is convicted by government criminal laws, or does not satisfy the KYC verification requirements, or is charged by other relevant regulations and bylaws.

**General Secretary (GS).** The General Secretary is elected by the Board of Steering Committee to be the contact and responsible representative of the Board. The General Secretary must be a member of the Steering Committee and is responsible for guiding and coordinating the

communications between functional committees and the Steering Committee. The general secretary cannot be an Employee Member of the board, defined as above.

**The first** Steering Committee members and general secretary are selected by the founders and subject to all the Steering Committee charter.

#### 2.4.2.2 Term, Retirement and Termination

**Term:** The term for the Steering Committee is two years fixed.

**Retirement:** The Board does not favor a mandatory retirement age for members. If any member of the Board cannot continue as a member during the term, the member should submit a written application to the Board stating the circumstances that do not allow continuation. Stakeholder members would count as independent members of the Board upon their resignation, removal or retirement as an employee of the stakeholder company. The stakeholder members who transfer their employment from one stakeholder to another would count towards the quota for new stakeholders they work for.

**Termination:** The members of the Board will be immediately terminated if the member 1) becomes disqualified as defined above; 2) has missed two board meetings without valid reasons; 3) have missed the annual meeting without valid reasons.

In the case of termination or voluntary leave, the members of the advisory board, in a predetermined order, will substitute the seat until the end of the fixed term. The substitute member cannot automatically become the candidate for the new board unless nominated during the nomination process as below.

#### 2.4.2.3 New Board Nomination and Election

**Nomination:** To ensure the stability of the Foundation, the existing members of the Steering Committee are automatically considered as candidates for the new Board. In the case of an existing member being unwilling to take the candidacy, the member should submit a written notice of withdrawal to the nomination committee.

The nomination committee can nominate up to 3 candidates (for the election of a new board with the same size) or 5 candidates (for the election of a new board with an increased size). We also allow people to apply to be candidates via written application, and the Foundation will define the process to assess the qualifications of the applicants and let the community vote for the candidates to be included in the shortlist of nominees.

The total number of shortlisted nominees cannot exceed twice the proposed number of the new board. The composition of the nominees shall be proportional to the composition of the new board. The shortlisted nominees shall be announced two months before the election by the nomination committee.

**Election:** the new Board of Steering Committee will be elected by eligible stakeholders with voting authority, two months before the term of the existing Board ends. The nominees will be ranked by number of votes and the membership will be granted to the candidates with the highest number of votes, based on predetermined Board size and the composition rule. The results of the election will be announced by the nomination committee.

## 2.4.3 Conduct of the Board of Steering Committee Meetings

### 2.4.3.1 Number of Meetings

The Board shall hold a minimum of four scheduled meetings per year. In addition to the regularly scheduled meetings, unscheduled Board meetings may be called, upon proper notice, at any time to address specific needs of the Foundation. The unscheduled Board meetings can be called upon from the chairs of the functional committee, members of the Steering committee, through the coordination of the General Secretary.

### 2.4.3.2 Selection of Agenda Items

The General Secretary, in coordination with the supporting administrative staff, should establish the agenda for Board meetings. Any member of the steering committee, the functional committee and the advisory board may request an item be included on any meeting agenda. One of the four scheduled Board meetings is designated as the annual meeting, scheduled one month before the fiscal year end of the Foundation.

#### The Agenda for Board Annual Meeting:

- 1) Review and approve the Foundation's one-year and five-year strategic plan;
- 2) Review and approve the proposals of technical, operational and public relations development for next year;
- 3) Review and approve the Foundation's annual budget;
- 4) Review and approve any adjustment to the content of the governance principles;
- 5) Review and approve any new appointment of functional committee members and leaders of the functional units;
- 6) Review and approve the operation model of VTHO (operating charge basis of the VeChainThor Blockchain) and value estimation of VET (including market making policies); and
- 7) Any other agenda items.

#### The Agenda for Other Scheduled Board Meeting:

- 1) Review new development of the Foundation and the progress towards the long-term strategic plan;
- 2) Review new development and challenges on the technical, operational, public relations and legal committees; and
- 3) Any other agenda items.

### **2.4.3.3 Attendance**

All members of the Steering Committee are expected to attend and participate in all Board and applicable committee meetings. For the annual meeting, all members should attend in person, unless there are special circumstances that do not allow the member to attend the meeting in person. In that case, the member should attend telephonically and notify the designated supporting administrative staff or the General Secretary in advance of the annual meeting.

For the other scheduled and unscheduled board meetings, members may attend in person or by voice or video calls. In the case that a member is unable to attend a meeting in person or by telephone or video, the member should notify the designated supporting administrative staff or the General Secretary in advance with written explanations of the circumstances.

### **2.4.3.4 Distribution of Materials; Board Presentations**

It is important for board members to have appropriate materials on topics that are to be discussed sufficiently in advance of the meeting date. Board members can generally expect to receive summaries and/or slides of presentations several business days in advance of the meetings to enable proper preparation. Members should review material distributed in advance of such meetings. In the event of a pressing need for the Board to meet on short notice or if such materials would otherwise contain highly confidential or sensitive information, it is recognized that written materials may not be available in advance of the meeting.

For each of the scheduled agenda items, the related person-in-charge should make a clear presentation to the board with supporting materials and slides.

### **2.4.3.5 Attendance of Non-Members**

The Board believes that attendance of key advisors, functional committee and unit leaders augments the meeting process and effectiveness. Members of the Advisory Board, functional committee and other functional unit employees may attend certain sessions of Board meetings by the invitation of the General Secretary.

Such persons should be prepared to respond to questions posed by Board members relating to their areas of expertise. Attendance of such individuals allows the most knowledgeable and accountable personnel to communicate directly with the Board.

### **2.4.3.6 Minutes**

The conclusions and decisions of the Board and Committees as well as any directives to functional units shall be recorded in the minutes of their meetings. The minutes of each meeting of the Board and its Committees shall be presented to and approved by the Board or the applicable Committee customarily at its next meeting. Signed Committee minutes shall be included in the Board materials as soon as possible after being approved by the Committee and signed by the applicable Chair and General Secretary.

### **2.4.4 Board Compensation**

Stakeholder and employee members of the steering committee shall not receive additional cash compensation for service on the board.

Independent members of the committee are compensated competitively as similar entities. The Steering Committee will periodically review the level and form of the independent board member compensation.

To ensure alignment and motivate the board members, a fixed amount of VET should be issued to all the members (except members from VeChain Foundation) of the steering committee and functional committee chairs, reviewed by the compensation committee.

The Foundation will cover all travel expense and accommodation for board members who are not located in the board meeting city at the time of each meeting.

## **2.5 Advisory Board**

### **2.5.1 Composition**

The Foundation seeks members from diverse professional backgrounds with a broad spectrum of expertise to serve on the Advisory Board. The number of advisors should not exceed the number of Steering Committee members. The advisors are selected by the board of Steering Committee based on diversity and expertise.

### **2.5.2 Membership**

The advisors must be independent with no direct association with any stakeholder of the Foundation. In the case of an advisor becoming associated with a stakeholder, the advisor should resign as the member of the Advisory Board upon his association.

Members of the Advisory Board, in a predetermined order, serve as standby members for members of the Steering Committee in the case of termination or voluntary leave of any existing Board member during the current term. The substitute members for the Board will serve until the end of the current term. The substitute member cannot automatically become the candidate for the new Board unless nominated by the nomination committee.

Members of Advisory Board shall be compensated with annual fixed VET compensation and travel expense for meeting attendance.

## **2.6 Functional Committees**

### **2.6.1 Committees**

The Board has established the following Committees: Technical; Operational; Public Relations; Regulation; Compensation; and Nomination. Each of the committees should be chaired by one of the Board of Steering Committee members or Advisory Board members and include key managers of the functional units as members. The Compensation and Nomination Committee should be chaired by an independent member of the Board of Steering Committee or a member from the Advisory Board. Committee assignments and the designation of Committee Chairs should be based on the members' knowledge, interests and areas of expertise.

The Board may, from time to time, form a new committee or disband a current committee depending on the circumstances. In addition, the Board may decide to form ad hoc committees or working groups from time to time and determine the composition and areas of responsibility of such committees.

### **2.6.2 Functional Committee Meetings**

All standing committees shall meet regularly during the year and receive reports from Foundation personnel on developments affecting the Committee's work. The Committee Chairs, as necessary, shall establish the frequency and length of Committee meetings. Committee members are expected to prepare for, attend, and participate in all Committee meetings and should use their best efforts to attend in person. When necessary, a member who is unable to attend in person may attend by telephone if appropriate under the circumstances. A member who is unable to attend a meeting in person and wishes to participate by telephone or video is expected to notify the Chairman of the Committee in advance of the meeting.

### **2.6.3 Committee Reports to the Board**

The Board agenda shall include regular reports from the Chairs of each of its Committees on their proceedings and deliberations. The Committees shall bring to the Board for consideration those matters and decisions which the Committees judge to be of special significance. These Committees shall additionally provide a written annual report to the Board on their key activities during the year. The written report will provide confirmation that the Committee has met all of its obligations under its Charter.

### **2.6.4 Function Committees**

#### **2.6.4.1 Technical Committee**

The technical committee comprises the core VeChain Blockchain technology developers. It has the following responsibilities:

- 1) Plan for the current and future development of the VeChainThor Blockchain, carry out the development and testing of the planned new technologies and report to the steering committee about the developmental progress;

- 2) Prepare technical documents, develop tools for and support individual or enterprise developers to develop applications on the VeChainThor Blockchain;
- 3) Monitor the status of the VeChainThor Blockchain and analyze and respond to any emergency to maintain system stability;
- 4) Monitor the usage of the VeChainThor Blockchain, collect usage and market data, work with economists to improve the economic model and suggest possible model parameter adjustment and report to the steering committee; and
- 5) Identify future blockchain-related research areas, conduct internal research projects, collaborate with research institutions on joint research projects and publish results in international conferences and journals.

#### **2.6.4.2 Operational Committee**

The Operational Committee has the following responsibilities:

- 1) Set up policies of reporting, and refine the responsibilities for the functional units. The committee gives oversight to the following: the Finance Unit; the Human Resource Unit; and the Administration Unit;
- 2) Together with the key managers of the finance unit, prepare budget plan, financing proposal, distribution plan and financial report to the Board of Steering Committee;
- 3) Together with the key managers of the Human Resource Unit, lay out the personnel structure of all the functional units of the Foundation. Make recommendations on talent search, compensation and incentives. Prepare proposals to the Compensation Committee and the Board of Steering Committee;
- 4) Together with the key managers of the Administration Unit, lay out the functional structure and responsibility of each department;
- 5) Facilitate the communications of the functional units with the board of steering committee; and
- 6) Other responsibilities approved by the Board of Steering Committee.

#### **2.6.4.3 Public Relation Committee**

The Public Relations Committee has the following responsibilities:

- 1) Promote the VeChainThor Blockchain and the Foundation with the community, stakeholders, business alliance and publicity;
- 2) Provide guidance to the Foundation's legal and compliance departments;
- 3) Retain healthy communications with the regulatory and supervisory departments of governments;



- 4) Set up procedures to ensure reporting transparency;
- 5) Deliver important documents and announcements to the VeChainThor Blockchain community, stakeholders, business alliance and publicity, when deemed appropriate by the Board of Steering Committee;
- 6) Other responsibilities approved by the Board of Steering Committee.

#### **2.6.4.4 Regulation Committee**

The Regulation Committee is responsible for ensuring the operating compliance of the Foundation to all relevant laws and regulations. Any important risk, challenge or issue should be included on the board meeting agenda.

The Regulation Committee is also responsible for supervising the internal audit for the daily operations to discover and report any wrong doings or situations of non compliance.

#### **2.6.4.5 Compensation and Nomination Committee**

The Compensation and Nomination Committee is responsible for setting the appropriate incentive system for the key managers of the functional units of the Foundation. The Committee shall establish procedures, subject to approval from the Board, to assess the performance of the management and apply incentive measures accordingly.

The Nomination Committee also has the responsibility of nominating candidates for the new Board of Steering Committee six months before the terms end of the existing board.

## **2.7 Communication and Disclosure**

### **2.7.1 Communication with the Board**

Interested parties wishing to communicate with the Board may send an email to [foundationboard@vechain.com](mailto:foundationboard@vechain.com). You may also communicate with the members of the board by email address to any individual member of the board, the full board, a specific committee or the independent members as a group directed to the Foundation Executive Secretary.

All communications received will be compiled by the Foundation administrative unit and submitted to the Steering Committee on a quarterly basis or more frequently as appropriate. Emails received via [foundationboard@vechain.com](mailto:foundationboard@vechain.com) are screened for junk commercial email and general solicitation. If the communication does not involve an ordinary business matter as described below and a specific board member is named, the communication will be forwarded to that member. In order to expedite a response to ordinary business matters, the Steering Committee has authorized designated staff to receive, research and respond, if appropriate, on behalf of our members, including particular members or its non-employee members, to any communication regarding an application or service, referred to as an “ordinary business matter.” Any board member may review any such communication or response thereto.

### **2.7.2 Disclosure**

To ensure the transparency of the operation of the Foundation, the board of Steering Committee will issue the annual and quarterly report to summarize the operation, new development, performance and potential risks of the Foundation. The board and committee composition and executives’ members should be disclosed in the annual report. Any significant event or changes in the Foundation’s operation, strategy and Board composition should be disclosed through communication platforms in a timely manner.

### **2.7.3 Ethics and Conflicts of Interest**

The Board of Steering Committee has adopted a Conflict of Interest Policy. The Conflict of Interest Policy incorporates various provisions of applicable corporate law, regulations and other standards adopted by the Foundation to ensure that Board and committee decisions are not impacted by conflicts of interest. Members of the Board are expected to avoid any action, position or interest that conflicts with an interest of the Foundation, or gives the appearance of a conflict, in accordance with the Conflict of Interest Policy and any rules adopted by the Foundation.

When faced with a situation involving a potential conflict of interest, members of the Board are encouraged to seek advice from the General Counsel from the legal unit or from outside counsels designated by the General Counsel.

## 3 Economic Model and Design

### 3.1 Background

Financial characteristics are inherent in every blockchain. A proper economic model is one of the fundamental elements in a blockchain ecosystem, and a key factor for its success.

After studying the economic models of most public blockchain networks, and several discussions with our business partners, especially corporations and enterprise business owners, we discovered the largest obstacle to adoption of massive applications on blockchain: the cost of using blockchain is directly linked to token valuation. While the token valuation usually goes up as the volume of use in the blockchain ecosystem increases, the cost of using blockchain dramatically varies depending on whether a party wishes to conduct payment transactions or smart contract transactions. This does not even mention the speculation and hype from investors and traders as a contributor to the value of a blockchain. No business owner would run applications or a business on blockchain, or anywhere, at an unpredictable and unstable cost.

This section describes the VeChainThor Blockchain economic model that governs the VeThor Token (VTHO) generation from VeChain Tokens (VET), an estimation of market demand and supply of VTHO, and VTHO price modeling principles. In summary, VTHO is generated via holding VeChain Tokens (VET) with velocity  $v$ , which is established to enable any user with VeChain Tokens (VET) to make transactions at no extra cost if the user holds the tokens for long enough.

Based on the VTHO generation model, we can estimate the supply and demand of VTHO for each given day and dynamically for one year after the VeChain mainnet is officially launched. The total supply of VTHO is calculated to be 37,459,858 each day with the current  $v$ . The demand of VTHO includes smart contract execution and payment transactions. The VTHO demand from the former is estimated by the forecast from the business development team and the VTHO demand from the latter by comparable cryptocurrency transactions data in the past three months. The dynamic estimation of supply and demand is presented in Section 3.4 To stabilize the VTHO price and maintain the equilibrium of demand and supply of VTHO, the Foundation might adjust variables of the economic model when the demand is close to the total supply of VTHO.

We additionally provide a general growth model for modeling token prices in Section 3.5. Generally, the VeChain Token (VET) price consists of three parts: the present value of all future VTHO generated; the present value of VeChain Tokens (VET) as a cryptocurrency; and the present value of the use of VeChain Tokens (VET) as value transfer media (or smart money) on the VeChain blockchain.

## 3.2 Model Design Philosophy

The basic principle of designing the model is to prevent transaction fees from being directly exposed to the volatility of the price of VeChain tokens, making the VeChainThor Blockchain more suitable for conducting business/financial activities for both individual and enterprise users.

In our design, there are two levels of VeChain blockchains (referred to henceforth as 'VeChain'). The lower level concerns Blockchain-level operations such as transferring tokens and executing smart contracts while at the higher level, VeChain holds applications that conduct complex business and financial activities.

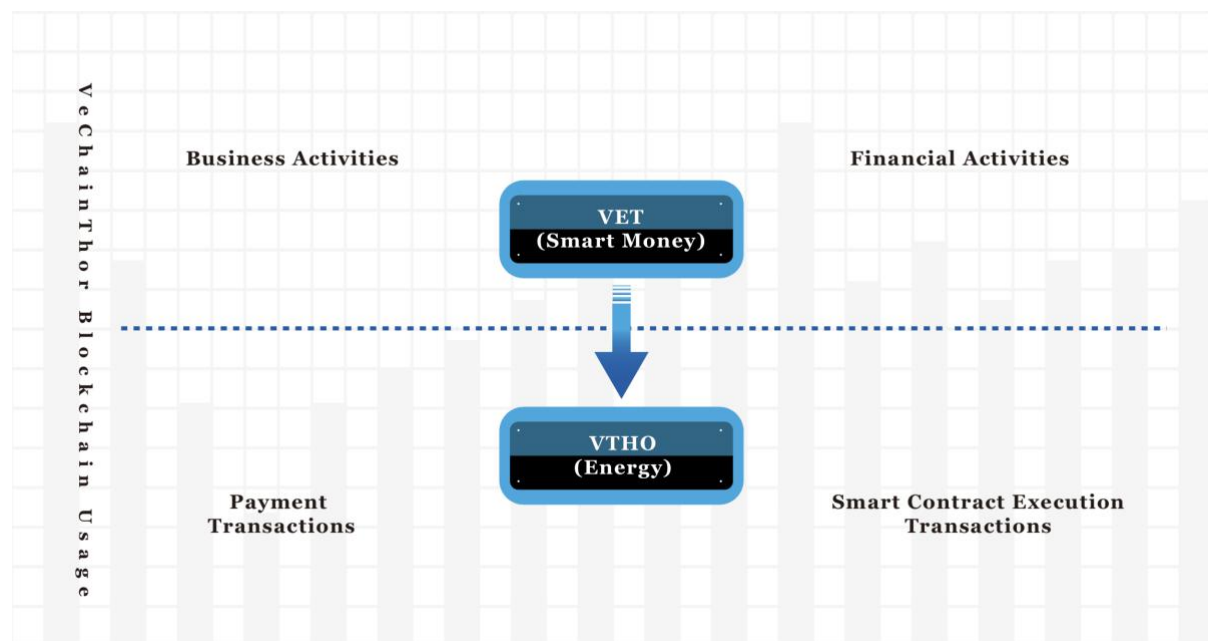

Figure 3.2.1 Two levels of VeChain blockchains

In our model, we design a twin-token system to facilitate activities at both levels, namely, VET and VTHO. The function of VET is to serve as value-transfer medium, or in other words, smart money, to enable rapid value circulation within the ecosystem based on VeChain. On the other hand, VTHO represents the underlying cost of using VeChain and will be consumed (or, in other words, destroyed) after certain blockchain operations are performed.

Since VET represents the right to use VeChain, the model is designed in such a way that VTHO is generated automatically via holding VET tokens. In other words, whoever holds VET will be given VTHO for free and be able to use VeChain for free as long as the operations performed consume less than the VTHO generated. The VTHO tokens can be transferred and traded to allow users to acquire extra VTHO for performing a larger scale of operations such as running an application hosted on the VeChainThor Blockchain.

### 3.3 Model Settings

Let us first define some variables to be used to describe our model settings.

$V$ : the amount of VET

$E$ : the amount of VTHO

$G$ : the amount of gas (in units of one thousand gas), where gas is the internal unit of VeChain to price various blockchain operations. The name ‘gas’ is adopted from the Ethereum blockchain system.

$t$ : the amount of time used to accumulate VTHO from VET. Note that  $t$  is counted in number of blocks rather than conventional time units.

$p$ : the gas price in VTHO

$v$ : the generation speed of VTHO from VET

Mathematically, we can write our model as:

$$E = v * V * t \quad (1)$$

$$E = p * G \quad (2)$$

Equation 1 tells us that there would be  $v$  VTHO generated from 1 VET every time a block is generated. Equation 2 shows how VTHO tokens are spent in the system. More specifically, when a transaction is put in a block, the system first calculates the amount of  $G$  required and then  $E$  using Equation 2, which means that there would be  $E$  VTHO spent. Note that  $p$  is set by the transaction initiator and can be different from transaction to transaction. A larger  $p$  would result in the transaction being processed with a higher priority at the cost of more VTHO consumed and vice versa.

We expect the use of VeChain to be modest at the beginning, but will increase rapidly in the next two years. We initialize the model parameters  $v$  and  $p$  such that the amount of VTHO generated from 1M VET every day will be enough for conducting twenty payment transactions. According to our design, VeChain will generate one block every 10 seconds and each payment transaction requires 21,000 gas. The current setting for parameter  $v$  is  $5 \times 10^{-8}$  VTHO per VET per block. Therefore, for 10K VET there will be 4.32 VTHO generated every  $6 \times 60 \times 24 = 8,640$  blocks (24 hours).

Ideally, most of the VTHO tokens generated would be spent to pay for transactions on VeChain. In our model, we give users the flexibility to vary  $p$  when submitting transactions. Theoretically, one could set a very small  $p$  to allow transactions to consume near zero VTHO. If a large number of users followed such a practice, there would be a large stock of VTHO unspent, increasing the uncertainty of the stability of VeChain.

In order to prevent  $p$  going below the minimum cost of running transactions, users can only choose  $p$  in the range of  $[p^{base}, 2 \times p^{base}]$  where we currently set  $p^{base} = 1$  VTHO/Kgas. We expect average  $p$  would be correlated with the number of applications running on the VeChain and active users who make transactions regularly. The minimum and maximum gas price in VTHO are designed to prevent people exclusively occupying the blockchain and harming other transaction makers. All the transactions that have a gas price outside the range would be delayed or not executed as a penalty by the system.

## 3.4 Estimation of Supply and Demand of VTHO

### 3.4.1 Supply of VTHO

According to baseline setting of  $v = 4.32$  VTHO per 10k VET per day, each user with 10k VET holding will generate 4.32 VTHO per day. On the whole VeChainThor Blockchain, there will be 37,459,858 VTHO generated from VET plus per day plus 30% of VTHO usage on that day rewarded to Authority Masternodes. Mathematically, we define the market supply of VTHO for one day as follows:

$$S_{Th,d} = \rho \cdot (v_d \cdot V \cdot (1 - \gamma) + 30\% \cdot D_{Th,d}) \quad (3)$$

where,

$S_{Th,d}$  is the market supply of VTHO each day;

$v_d$  is the velocity of VTHO generated each day for every 10K VeChain Tokens (VET);

$V$  is the total number of VeChain Tokens (VET);

$\rho$  is the percentage of users actively trading VTHO each day ('active traders');

$\gamma$  is the percentage of tokens held by the Foundation; and

$D_{Th,d}$  is the total VTHO usage each day of which 30% is awarded to Authority Masternode holders who are assumed to be at the same participation ratio  $\rho$ .

Note - All VET has a base generation in this method.

### 3.4.2 Demand for VTHO

The demand for VTHO includes two parts: smart contracts deployed on the VeChainThor Blockchain by enterprise users through applications and individual transaction payments.

The demand of VTHO by smart contract usage can be estimated as:

$$D_{Th,d,SC} = K \cdot p_{TH/KG} \cdot \sum_{i=1}^N ID_i \cdot \theta_{i,d} \cdot L_i \quad (4)$$

where,

$D_{Th,d,SC}$  is the market demand of VTHO each day by smart contract execution;

$ID_i$  is the average number of IDs each application has;

$\theta_{i,d}$  is the average number of transactions associated with each ID per day;

$L_i$  is the likelihood of the application  $i$  taking place;

$K$  is the estimated average gas usage for each smart contract execution; and

$p_{TH/KG}$  is the VTHO per 1k-gas price.

We will use this estimation in our baseline model of individual transaction payments:

$$D_{Th,d,TX} = TX_d \cdot K_{TX} \cdot p_{TH/KG} \quad (5)$$

where,

$D_{Th,d,TX}$  is the market demand of VTHO each day

$TX_d$  is the estimated number of transactions each day;

$K_{TX}$  is the fixed 21 Kgas usage for each transaction payment; and

$p_{TH/KG}$  is the VTHO per Kgas price.

The total demand for VTHO, therefore, is estimated to be

$$D_{Th,d} = D_{Th,d,SC} + D_{Th,d,TX}, \quad (6)$$

### 3.4.3 Transaction Cost

The design of the Twin-Token model intends to maintain some sustainable transaction cost of using VeChain Blockchain. Depends on the market participation of the VTHO market and the demand and supply of VTHO, the Foundation would adjust the minimum price of VTHO per gas,  $p_{TH/KG}$  to achieve its goal. If there is a clear long term trend or the adjustment of minimum  $p_{TH/KG}$  does not effectively stabilize the transaction cost, the Foundation would adjust VTHO generation velocity  $v$ .

The Supply of the VTHO is based on the current velocity. The demand of VTHO for the next six months is estimated by a combination of econometric forecasting models with the adjustments by the inputs from the business development and marketing teams. The forecasting technique will be continuously tested against all available data. Different models might be adopted to estimate the VTHO demand from the payment transactions and smart contracts. The market participation ratio will be estimated using historical data.

### 3.5 Token Price Modelling

Our token price model is built on the share price model that has been widely in the financial industry and probably is the closest thing we can borrow from our experiences. In general, VTHO could be considered as a new kind of utility accrued by holding the VeChain Token (VET). In particular, we consider the price of VET as resulting from three parts: 1) VET generates VTHO; 2) the future appreciation of VET; and 3) that VET tokens are used as smart money.

The general model of the valuation of VeChain Token (VET) is designed as followings:

$$P = \frac{E}{r-g} + PVG_c + PVG_B \quad (7)$$

where,

$P$  is the market price of VeChain Token (VET);

$E$  is the market VTHO price;

$r$  is the discount rate, related to the rate of return by holding VeChain Token (VET);

$g$  is the growth rate of velocity of VTHO generation;

$PVG_c$  is the present value of the present and anticipated future use of VET as a cryptocurrency. It can be estimated based on the growing perspective of the whole cryptocurrency industry or several comparable coins;

$PVG_B$  is the present value of the present and anticipated future use of VET as smart money on VeChain. It can be estimated based on the growth of development of applications and business strategic collaboration in the future.

To have some idea of what values these variables have, we take the stock price data from the current top 10 high tech companies and after calculation have the following results:  $\frac{PVG_c}{P} = 80\%$  and  $r - g = 0.05$ . For  $PVG_B$ , we cannot make any guess since we would need future data to evaluate it.

The assumptions behind the pricing model are based on theoretical research and we believe the actual price will be and should be decided by the market based on the fundamental understanding that VTHO will be serving as the cost to use VeChainThor Blockchain which is expected to be stable, controllable and predictable to support applications running on the platform. VeChain Foundation will announce and implement a series of macro-control measures in near future.



## 3.6 Economy Masternodes

A VeChain Economic Node is one that offers stability to the ecosystem and act as a distribution of power and privilege within the blockchains economy. VeChain Economic Nodes also have a representation within the ecosystems voting periods. For each 10,000 VET held by a node, they represent one vote within the majority consensus. Unlike Authority Nodes, Economic Nodes do not produce blocks and ledger records.

To qualify as an Economic Node you must hold above 1,000,000 VET and are defined by the following minimum VET holdings (after mainnet launch and 1:100 Token split):

- Mjolnir - 15,000,000 VET
- Thunder - 5,000,000 VET
- Strength - 1,000,000 VET

Economic Nodes are rewarded a portion of VTHO generated by a pool of VET set aside by the foundation. The allocated VET in VTHO Reward Pool reduces by 2.5 billion every 6 months, until further notice after 2019\*.The allocation of VET by the foundation is as follows (after mainnet launch and 1:100 Token split):

Period	VET in VeThor Reward Pool
From Mainnet Launch to 31 <sup>st</sup> Dec 2018	15 billion VET
From 1 <sup>st</sup> Jan 2019 to 30 <sup>th</sup> Jun 2019	12.5 billion VET
From 1 <sup>st</sup> Jul 2019 to 31 <sup>st</sup> Dec 2019	10 billion VET
.....	.....

These rewards will be distributed to the Economic Nodes and do not replace the base generation of VTHO the held VET produces.

Assuming the following (after mainnet launch and 1:100 Token split):

B = Base VeThor generation rate for 1 VET held (0.000432 VTHO Power a day);

FR = Amount of VET distributed from the Foundation Reward Pool (15 billion VET);

F = Amount of VTHO the Foundation Reward Pool generates per Day (15 billion VET x 0.000432 = 6,480,000 VTHO);

A = Number of Authority Node designated VET (101 nodes x 25,000,000 = 2,525,000,000 VET);

M = Number of Mjolnir Masternodes designated VET (variable);

T = Number of Thunder nodes designated VET (variable);

S = Number of Strength nodes designated VET (variable);

NB = BASE reward generation rate for all Nodes.

Economic Nodes extra VeThor reward formula , F, M, T, S is known, Solve for NB:

$$F = (A * NB * (1 + 100\%)) + (M * NB * (1 + 100\%)) + (T * NB * (1 + 50\%)) + (S * NB * (1 + 0\%))$$

### 3.6.1 Node Maturity Period

“Node Maturity Period” is a term used in the VeChain ecosystem, meaning once a wallet has the amount needed to qualify for a certain node and the corresponding amount stored in ‘VeThor Forge’, the built-in function in VeChain wallet, then the Node Maturity Period starts to count.

When the maturity period ends, and the quantity of VET stored in ‘VeThor Forge’ does not drop below the threshold at any given moment, then the node status will be officially designated, and the node reward will start to generate.

**Mjolnir Masternodes Maturity Period:** 30 Days after VeChain Thor Blockchain mainnet launch; Requires minimum 15,000,000 VET;

**Thunder Nodes Maturity Period:** 20 Days after VeChain Thor Blockchain mainnet launch; Requires minimum 5,000,000 VET;

**Strength Nodes Maturity Period:** 10 Days after to VeChain Thor Blockchain mainnet launch; Requires minimum 1,000,000 VET;

Any change of VET that results in a change in node type also activates the Node Maturity Period after the mainnet launch. An example being, if a node moves from 1,000,000 VET to 5,000,000 in the VeThor Forge Wallet, the 20 day maturity period begins before the Economy Node generates the new additional reward per VET, outside of the VET’s normal VeThor generation speed.

### 3.6.2 X-Nodes

X-Nodes are an additional pool of VET set aside for early supporters. To see the perks offered to early supporters please view the [X-Node release](#).

## 4 VeChainThor Core

VeChainThor Blockchain is a public blockchain that is designed for mass business adoption of Blockchain technology to business owners, both enterprises or individuals. It is intended to serve as a solid foundation for implementing our novel governance and economic models and to support a sustainable and scalable ecosystem.

We are in the era where Ethereum [1, 2] represents the state of the art in public blockchains since 2014 and 2015. Some of the great ideas have included the introduction of an account model such that the “state” in the fundamental transaction-based state machine model can store information not restricted to the balance information; the concept of a “smart contract” that allows blockchain to describe more complicated objects and activities in the real world through consensus-based computations and the invention of the Ethereum Virtual Machine (EVM) and the EVM code that enables smart contracts.

Despite being a major technological milestone, Ethereum has not been made suitable for hosting large-scale commercial decentralized applications (DApps) that could engage our day-to-day activities. One of the main reasons is that there hasn’t been an effective governing structure set up, from the very beginning, for Ethereum to allow efficient and transparent transitions (upgrades) of itself to adapt to new challenges. Secondly, Ethereum lacks a suitable economic model to allow enterprises to run their DApps with a controllable and predictable cost. Considering the level of volatility of the Ether price, it is almost impossible for companies to predict the future price of Ether or the cost of running a DApp based on Ethereum for a period of time.

The VeChainThor Blockchain is designed to tackle the above problems. It does not just provide pure technical solutions but is empowered by novel governance and economic models, which, we believe, will push forward broader blockchain adoption and the creation of ecosystems with more trust and efficiency. The VeChainThor Blockchain is not built from scratch, but upon some of the essential building blocks of Ethereum (e.g., the account model, EVM, modified Patricia tree and RLP encoding method). But most importantly, it is packed with technical features that are tailor-made for the actual needs of both enterprise and individual users. We believe that the new features give both users and developers added flexibility and powerful tools to achieve their goals on the VeChainThor Blockchain.

## 4.1 Payment Model

One of the major obstacles for ordinary people, or even enterprises, to adopt a public blockchain is the uncertainty and complexity in dealing with cryptoassets. On the one hand, users have to face the high price volatility when obtaining cryptocurrency from the market; on the other hand, they need to understand related concepts and get familiar with various tools to be able to use and manage their cryptocurrency.

So, is there a way for us to find a way around these problems? For the existing Blockchain networks such as Bitcoin and Ethereum, the answer is negative. This is due to the fact that whenever we use the Blockchain service, whether it is transferring money or operating smart contracts we have to send transactions to the network and pay for the transactions using our own account balance.

In the VeChainThor Blockchain, we recognize this critical problem and come up with a novel multi-layer payment model as illustrated in the following figure.

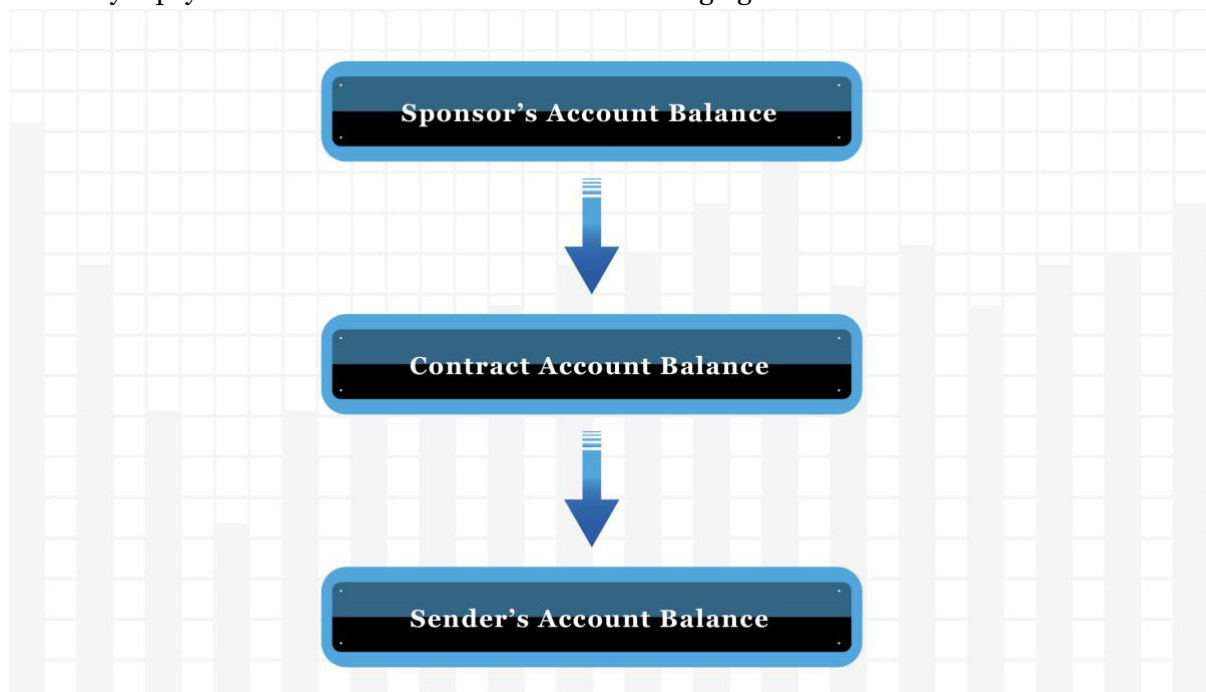

*Figure 4.1.1 VeChainThor Blockchain Payment Model*

It can be seen that a VeChainThor Blockchain transactions can possibly be paid by three different parties. From bottom to top, they are the transaction sender, the transaction recipient and the sponsor of the smart contract. When charging the transaction fee, the system undertakes the following steps:

- 1) The system checks a) whether the sender is allowed to waive his or her transaction fee and b) whether the smart contract sponsor agrees to pay the fee. If both answers are yes, it tries to deduct the fee from the sponsor's account balance. If the fee charging fails (e.g., due to insufficient funds available) or the second answer is no, it proceeds to Step 2.

- 2) If the first answer is yes, the system tries to deduct the transaction fee from the smart contract's account balance. If the fee charging fails or the answer is no, it proceeds to Step 3.
  
- 3) The system tries to deduct the transaction fee from the sender's account balance. If the fee charging fails, it returns an error.

In terms of the payment structure, the proposed model provides a great deal of flexibility and convenience for enterprises to develop their DApps on the VeChainThor Blockchain. For instance, the sponsor mechanism allows an enterprise to better work with its business partners who do not want to deal with crypto assets. It also enables an enterprise to manage its multiple DApps more effectively and efficiently since it can use a master account to sponsor multiple smart contracts and it simply needs to ensure that the master account has sufficient funds to pay for transaction fees. Furthermore, the payment model makes it possible for ordinary people to use DApps running on the VeChainThor Blockchain just in the same way they use their non-decentralized apps nowadays. All they need to deal with is the public and private key pairs, which is not a difficult job for them since most of us are already dealing with dozens of username/password pairs every day.

## 4.2 Transaction Model

The VeChainThor Blockchain adopts a new transaction model to solve some of the fundamental problems that hinder a broader use of blockchain at the moment. Specifically, a VeChainThor Blockchain transaction includes the following fields:

- **ChainTag** – last byte of the genesis block ID for preventing the cross-chain replay attack;
- **txNonce** – transaction nonce customizable by user;
- **Clauses** – an array of “clause” objects each of which contains fields “To”, “Value” and “Data” to enable single “from” coupling with multiple “to”;
- **DependsOn** – ID of the transaction on which the current transaction depends;
- **BlockRef** - reference to a specific block stating the indications of block height and partial ID of block;
- **Expiration** – number of blocks that can be used to specify when the transaction expires;
- **gasPriceCoef** – coefficient used to calculate the total gas price;
- **gas** – maximum amount of gas the sender is willing to pay for the transaction;
- **Reserved** - Reserved field for backward compatibility;
- **Signature** - signature of the hash of the transaction body  $\Omega$ , that is,  $signature = sign(hash(\Omega), private\_key)$ .

We now explain our design in more detail in the context of the corresponding problem we attempt to solve.

### 4.2.1 Transaction ID vs Account Nonce

In the Ethereum account model, the account nonce is used as a counter to make sure each transaction can only be used once. Although it provides a solution to replay attacks, in practice such a mechanism has proven to be troublesome, especially for enterprise users. For instance, if a user sends out multiple transactions at the same time (which is very likely for an enterprise user when, for example, registering products or updating records) and one transaction fails, all those with a larger nonce would be rejected by Ethereum nodes.

We scrap the account-nonce mechanism and introduce the concept of the transaction ID. In the VeChainThor Blockchain, every transaction is given a unique ID,  $TxID$ , which can be calculated as:

$$TxID = hash(hash(\Omega), signer\_address)$$

where  $\Omega$  is the set that contains all the transaction fields listed above except the field “Signature”.

In the VeChainThor Blockchain, when validating a given transaction, instead of checking the current account nonce, the system computes its  $TxID$  and checks whether it has been used before. Now let us revisit the problems we want to solve: 1) how to prevent the replay attack and 2) how to safely send off multiple transactions at the same time. Suppose Alice has signed a transaction that sends 10 VET to Bob and Bob wants to re-use the transaction to withdraw more money from Alice. Obviously, this is not going to work for Bob. Since the two transactions have the same ID, the one broadcast by Bob would be rejected due to the existence of the transaction ID.

Regarding the second problem, for any two transactions, as long as they had a field with different values, their transaction IDs would be different. Moreover, we can always adjust the transaction nonce to result in a new ID. With such a mechanism, users can easily produce multiple transactions with different IDs, which means that they could be sent off at the same time and would be processed by VeChainThor Blockchain independently.

#### 4.2.2 Transaction Dependency

Every VeChainThor transaction includes novel fields *DependsOn*, *BlockRef* and *Expiration* related to transaction dependency.

- *DependsOn* stores the ID of the transaction on which the current one depends. In other words, the current transaction cannot be validated without the **success** of the transaction referred by *DependsOn*. Here by “success”, we mean that the referred transaction has not only been included in the blockchain but been executed successfully (without any error returned by the system).
- *BlockRef* stores the reference to a particular block whose next block is the earliest block the current transaction can be packed. The reference (an eight-byte array) includes two parts: the first four bytes contains the block height (number) and the second four bytes a part of the referred block’s ID. In practice, the second part of *BlockRef* does not have to be assigned value if the block is not available (e.g. a block in the future).
- *Expiration* stores the number of blocks that can be used to specify when the transaction expires. Specifically, *Expiration* plus *BlockRef[:4]* (this refers to the integer value of the first four bytes of *BlockRef*) defines the height of the latest block that the transaction can be packed into.

Field *DependsOn* allows us to formally define an order for a sequence of transactions on the VeChainThor Blockchain and such an order is protected by the blockchain consensus. In Ethereum, only transactions sent by the same account can be configured with a deterministic order – i.e. defined by a nonce. In this system a transaction with a smaller nonce has to be executed before those with a larger nonce. However, for transactions from different accounts, there is no simple way to make sure a certain transaction executed before another. Moreover, the VeChainThor Blockchain requires a transaction on which another transaction depends not only to be included in a verified block but to be executed without any error returned by the system. However, Ethereum only requires the inclusion of the transaction without verifying the status of the transaction execution.

Field *BlockRef* can be used in two ways according to its above description. It can be used to prove the time a particular transaction is assembled. By contrast, in most blockchain systems, although the time at which a transaction is broadcast to the network is known, information on when the transaction was created is not known. In such cases, it cannot be easily determined if a transaction was created and then held for some period of time before it was sent to the blockchain network. On the VeChainThor Blockchain, the sender has to fill in all the bytes of *BlockRef* based on the existing block available to the sender.

*BlockRef* can also be used to delay the acceptance of the transaction by setting a block height in the future. In that case, the second four bytes of *BlockRef* can be left empty since the referred block is not available. For instance, Alice may want to send some money to Bob at some specified

time in the future. She can set up a proper *BlockRef* and then send off the transaction or give the signed transaction to Bob.

Field *Expiration* allows us to expire the transactions we send off. With such a handful feature, we would no longer be troubled by the situation that a transaction was stuck for hours or even days waiting to be processed and we could not do anything about it. The inclusion of *Expiration* would make our transactions safer since it prevents them from being hijacked and later re-used to cause problems.

### 4.2.3 Transaction-Based Proof of Work

Most have probably experienced the frustration when your Ethereum transaction gets stuck for hours or even days. Sometimes, we must set up a ridiculously high gas price to attract the miner to pack the transaction into the next block. Is raising the gas price (or, equivalently, paying more for the transaction) the only way for us to increase the priority of our transaction?

With the VeChainThor Blockchain, the answer is NO. We allow the Proof of Work (PoW) [1-3] to be conducted for every transaction so that transaction senders are given the choice to mine extra gas price, or in other words, to utilize their local computational power to increase the gas price of their transactions, rather than restricted to paying a higher transaction fee. In particular, the sender can prove his or her committed computational work through transaction field “Nonce” similar to the PoW mechanism implemented in the existing Blockchain systems. The amount of work is then converted to a factor that is used to compute the overall gas price of the transaction.

Note that the transaction sender is not given an infinite amount time to search for the desirable nonce. The underlying mathematical problem takes transaction field “BlockRef” into account. As described above, BlockRef is used to refer to a particular block. When validating the PoW, the system matches the second four bytes of BlockRef with the ID of the block identified by the first four bytes. If positive, it computes the gap between the referred and current blocks in number of blocks. Only if the gap is below the maximum gap allowed, the PoW is considered valid and affects the transaction’s overall gas price.

### 4.2.4 Multi-task Transaction

Another novel built-in feature is that the VeChainThor Blockchain allows a single transaction to carry out multiple tasks. To do that, we define the “Clause” structure that represents a certain on-blockchain task. Each Clause contains three fields:

- To – recipient’s address;
- Value – amount transferred to the recipient;
- Data – either the EVM code for account initialization or some input data [2].

We then define field “Clauses” as a set of Clause objects in the transaction model to make it possible for a transaction to conduct multiple tasks. The “Clause” model may remind you of the classic BitCoin “UTXO” model [3] since both models allow a transaction to have multiple output. However, with “Clauses” users can do a lot more than a set of output balance information can.

The multi-task mechanism has two main characteristics:



- Since the tasks are contained in a single transaction, their executions can be considered as an atomic operation, meaning that, they either all succeed, or all fail.
- During the transactions execution, the included tasks are processed one by one in the order defined by the fields Clauses.

We can see that the multi-task mechanism offers us a great deal of power and flexibility to deal with complex situations in real applications. For instance, it can provide simple and systematic solutions to fund distributions, mass product registration, or any other operations that require the execution of multiple tasks as a whole. Moreover, due to the second characteristic (the included tasks are processed one by one in the order defined by field Clauses), it can provide a secure and efficient way to describe a multi-step process. We would expect the design of the multi-task transaction to substantially simplify the development of many applications on the VeChainThor Blockchain.

## 4.3 Proof of Authority

One of the biggest decisions when designing a Blockchain system is about selecting and then implementing the consensus protocol. The consensus protocol not only dictates how the consensus on the state of the blockchain can be reached within a decentralized network but embodies the governance model designed and imposed upon a blockchain system. Recall that the underlying design philosophy of our governance model is that:

*Neither total centralization nor a total decentralization are the correct answer, but a balance of both.*

The mainstream protocols such as the Proof of Work (PoW), Proof of Stake (PoS), and Delegated Proof of State (DPoS) are not suitable for our system. Instead, the VeChainThor Blockchain carries the creation of our Proof of Authority (PoA) consensus protocol suiting the need governance setting so that there would not be anonymous block producers, but 101 known validators (Authority Masternodes) authorized by the VeChain Foundation and VeChain community.

*“It takes twenty years to build a reputation and five minutes to ruin it. If you think about that, you’ll do things differently.” – Warren Buffett*

To be an Authority Masternode (AM) on the VeChainThor Blockchain, the individual or entity voluntarily discloses who they are (identity and reputation by extension) in exchange for the right to validate and produce blocks [4]. It is their identities and reputations placed at stake that give all the AMs additional incentives to behave and keep the network secure. In VeChainThor, each AM has to go through a strict know your customer (KYC) procedure and satisfy the minimum requirements set by the Foundation.

Before getting into details, we summarize the main characteristics of the PoA protocol we implement in VeChainThor Blockchain:

- 1) Low requirement of computational power;
- 2) No requirement of communication between AMs to reach consensus;
- 3) System continuity independent of the number of available genuine AMs;

### 4.3.1 Protocol in Detail

When discussing a consensus protocol, we have to answer the following three basic questions: “When is a block produced?”, “Who generates the block?” and “How to choose from two canonical (legitimate) blockchain branches the one and only version of truth (the trunk of the blockchain tree)?”

#### 4.3.1.1 When

The VeChainThor Blockchain schedules its blocks to be generated once every  $\Delta$  seconds. At the moment, we set  $\Delta = 10$ , which is based on our estimation of the usage of VeChainThor after its

official launch. Let  $t_0$  be the timestamp of the genesis block. The timestamp of the block with height  $n > 0$ ,  $t_n$ , must satisfy  $t_n = t_0 + m \cdot \Delta$  where  $m \in \mathbb{N}$  and  $m \geq n$ .

### 4.3.1.2 Who

The PoA protocol ensures that every available AM has an equal opportunity to be selected to produce blocks. However, from a system-security point of view, we do not want the order for AMs to generate blocks to be totally deterministic. To do that, we introduce a deterministic pseudo-random process (DPRP) and the concept of the “active/inactive” status of AMs to decide whether a particular AM  $a$  is legitimate for producing a block  $B(n, t)$  with height  $n$  and timestamp  $t$ . Here  $t$  must satisfy  $(t - t_0) \bmod \Delta = 0$ . To answer the above question, we first define the DPRP to generate a pseudo-random number  $\gamma(n, t)$  as:

$$\gamma(n, t) = \text{DPRP}(n, t) \triangleq \text{hash}(n \circ t)$$

where  $\circ$  denotes the operation that concatenates two byte-arrays.

Let  $A_B$  denote the set of AMs with the “active” status associated with  $B$ . To verify whether  $a$  is the legitimate AM for producing  $B(n, t)$ , we first define

$$A_{B(n,t)}^a = A_{PA(B(n,t))} \cup a$$

and then compute index  $i^a(n, t)$  as:

$$i^a(n, t) = \gamma(n, t) \bmod \|A_{B(n,t)}^a\|$$

where  $PA(\cdot)$  returns the parent block. AM  $a$  is the legitimate producer of  $B(n, t)$  if and only if  $A_{B(n,t)}^a[i^a(n, t)] = a$ . Note that we put double quotes around the word “active” to emphasize that the status does not directly reflect whether a certain AM is actually physically active or not at that time, but merely a status derived from the incoming information from the network.

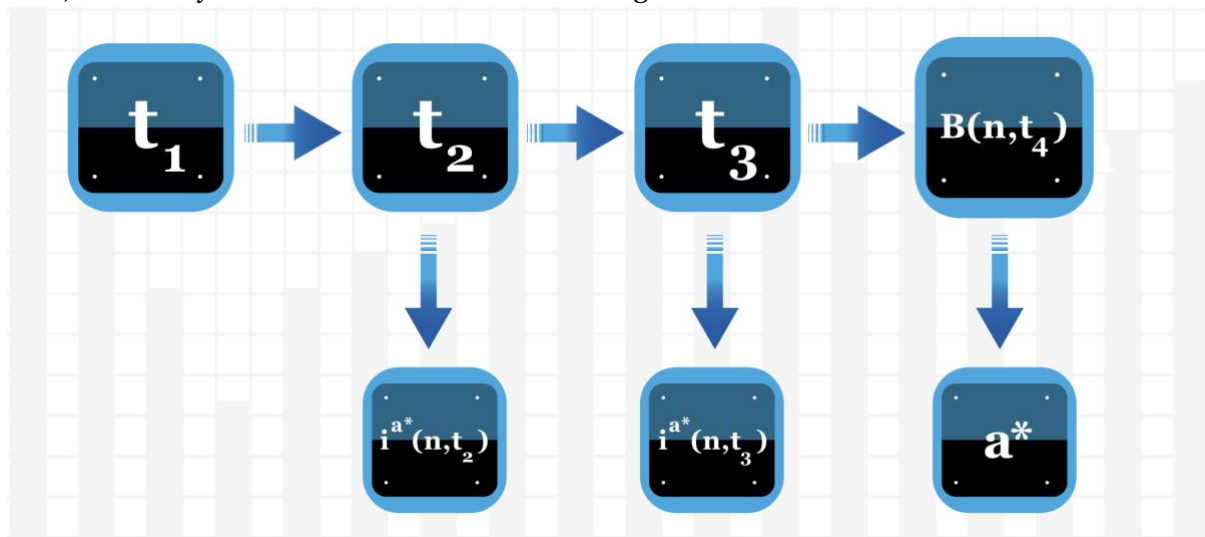

Figure 4.3.1 AM in PoA producing blocks

Let us discuss more about how the status is updated for AMs. Take the situation illustrated in the above figure. It shows four allowed time slots  $\{t_1, t_2, t_3, t_4\}$  for block production. The solid line

marks the verified blocks produced on time while the dashed line the missing blocks. For each time slot, the system can compute the index of the responsible AM using the above equation. The system sets the status of any AM that fails to produce a block as “inactive” and the status of the current block’s producer as “active”. In this example, after the system verifies  $B(n, t_4)$ , it updates the AM status associated with  $B(n, t_4)$  as:

- $A_{B(n,t_4)}^{a^*}[i^{a^*}(n, t_2)] \leftarrow inactive$
- $A_{B(n,t_4)}^{a^*}[i^{a^*}(n, t_3)] \leftarrow inactive$
- $a^* \leftarrow active$

where  $a^*$  is the signer of  $B(n, t_4)$ .

From the above description, it can be seen that any missing block before a legitimate block timestamp  $t$  would completely change the order of the AMs that produce blocks afterwards. It would hence be more difficult for attacker(s) to find out who is responsible for producing a number of consecutive blocks at a time relatively far from now. Furthermore, the VeChain Foundation could deliberately let the AMs it controls skip producing a block occasionally to increase the unpredictability.

#### 4.3.1.3 How to choose the trunk?

The final question we need to answer is how to choose the “trunk” from two canonical blockchain branches. Since there is no computational competition in PoA, the “longest chain” rule [1,3] does not apply. Instead, we consider the better branch as the one witnessed by more authority nodes. To do that, we compute the accumulated witness number (AWN) for block  $B(n, t)$  as:

$$\pi_{B(n,t)} = \pi_{PA(B(n,t))} + \|A_{B(n,t)}\|$$

Since  $\|A_{B(n,t)}\|$  computes the number of AMs with “active” status associated with  $B(n, t)$ , it can be considered as the number of AMs that witness  $B(n, t)$ . Therefore, we choose the branch with the larger AWN as the trunk. If the AWNs are the same, we choose the branch with less length.

Formally, given two branches  $B$  and  $B'$  with latest blocks  $B(n, t)$  and  $B'(n', t')$ , respectively, we first calculate their AWNs  $\pi_{B(n,t)}$  and  $\pi_{B'(n',t')}$ . The system then makes the following decision: choose  $B$  as the trunk if  $\pi_{B(n,t)} > \pi_{B'(n',t')}$ ; or choose  $B'$  if  $\pi_{B(n,t)} < \pi_{B'(n',t')}$ . In case  $\pi_{B(n,t)} = \pi_{B'(n',t')}$ , choose  $B$  if  $n < n'$  and  $B'$  if  $n > n'$ . If  $n = n'$ , keep the current trunk.

#### 4.3.1.4 System Continuity

When we consider a system’s performance, it is important that we test the system continuity, or in other words, to find out in what situations that the system would halt. According the PoA protocol described above, the whole system does not require a minimum number of genuine validators to be available, like the practical Byzantine fault tolerance (PBFT) [5] protocol does, so as to perform multiple rounds of inter-node communications to reach consensus. No external factors could prevent an Authority Masternode from continuously performing the PoA protocol and reaching consensus about the current Blockchain state based on the information it receives from the network. In this way, the PoA protocol endows VeChainThor with substantial robustness and stability.

### 4.3.2 51% Attack

Simply speaking, the PoA protocol is vulnerable to the so-called “51% attack”. The term is originally used to describe a certain type of attack to the PoW based Blockchain systems such as Bitcoin and Ethereum. In that case, the “51%” stands for more than half of the network mining power. It surely should have different meanings in the context of other consensus protocols. In PoA,

*the “51%” means more than half of the current available Authority Masternodes who collude.*

It sets a requirement not only on the number but, more importantly, on the assumption that the rebel Authority Masternodes collude, which, in reality, significantly increases the difficulty of carrying out such a 51% attack.

### 4.3.3 Long Range Attack

The long-range attack is one of most common ways to attack a Blockchain system. In this attack, the attacker goes back to an old block, generates a new Blockchain branch and broadcasting the branch to try to override the existing trunk. Very often, the fabricated branch is much longer than the trunk so as to fool the consensus protocol.

Normally, long-range attacks cannot be used to attack the proposed PoA protocol. The below figure illustrates a long-range attack to PoA where the white blocks represent the trunk while the grey blocks the fabricated branch. On one hand, since there has to be a  $\Delta$ -second interval between two consecutive blocks, it is impossible for the attacker to produce a significantly longer chain. On the other hand, PoA chooses the trunk based on the accumulation of the number of “active” Authority Masternodes. In that sense, to replace the current trunk with the fabricated branch, the attack has to gather more than half of the available Authority Masternodes to produce a larger total number. The attack would then become a 51% attack which has been described above.

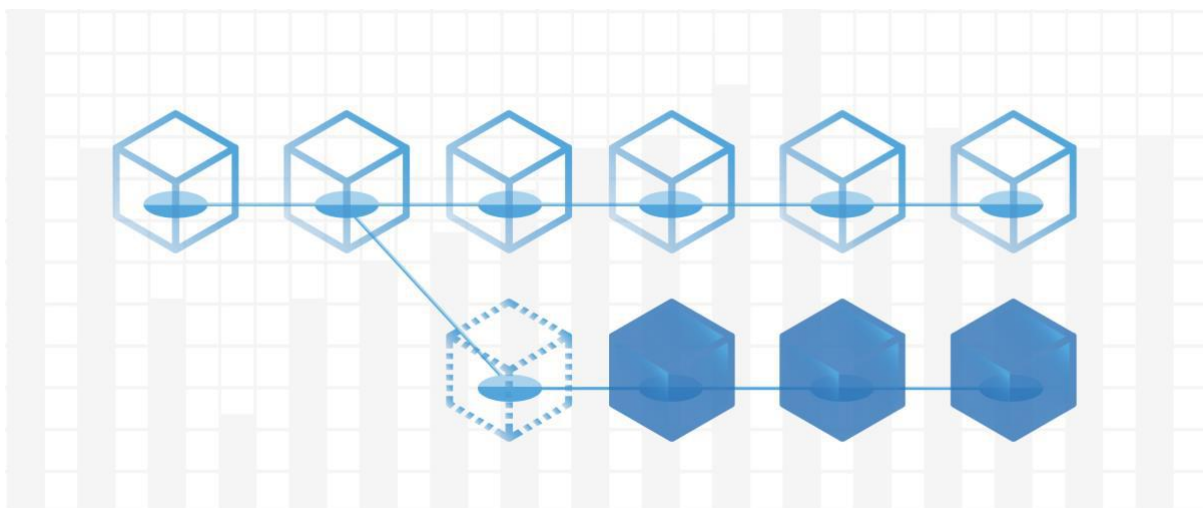

Figure 4.3.3 Long range attack

## 5 Architecture and Applications Development

### 5.1 Methodology of Development

VeChain's mission has never changed actually from the very beginning. It is to bring blockchain technology down to earth to deliver applications with business values by solving problems and making improvements. The future entire ecosystem will be a network, new-born business models and services will act as links for new connections, and novel business applications as dots representing new beginnings.

Blockchain is the Trust Machine and cornerstone of a trust-free ecosystem. The future world on Blockchain is expecting a universal digitalization for every element to run on it such as people, objects, and funds. VeChain's methodology is to transform the real business world through the following steps:

- 1) Digitize manageable target which can be recognized, accessed and managed by any participants. VeChain uses the unified VeChain ID (VID) to mark the target which can be presented by IoT tags or sensors to build up connections between the physical presence of the target and its digital avatar on Blockchain;
- 2) Build up immutable connections between the VID and the hashed data of the target to elaborate the authenticated and sharable profiles of the target;
- 3) Use smart contracts to describe the trust-free business activities of the target such as production, authorization, ownership transfer, business agreements and transactions, and so on;
- 4) The programmable VeChain Token (VET) acts as value carrier in the different business activities for efficient and high speed value transfer;
- 5) Discover and create a new type of trust-free interconnected business model with proper products and services;
- 6) Business applications, assets, products, services, community participants and activities form a trust-free business ecosystem.

Guided by this methodology, VeChain is able to “translate” the target product, participants and business activities from the real business world into the world of blockchain. In this way we can digitize the cooperation and systematize the operation at a larger scale across industries, enterprises and individuals. The cost of trust and collaboration will be greatly reduced not only for single entities, but also to industries, countries and even the entire world. Resource optimization will be possible at a greater level with everyone's involvement and new business models will be expected to be born from these possibilities.

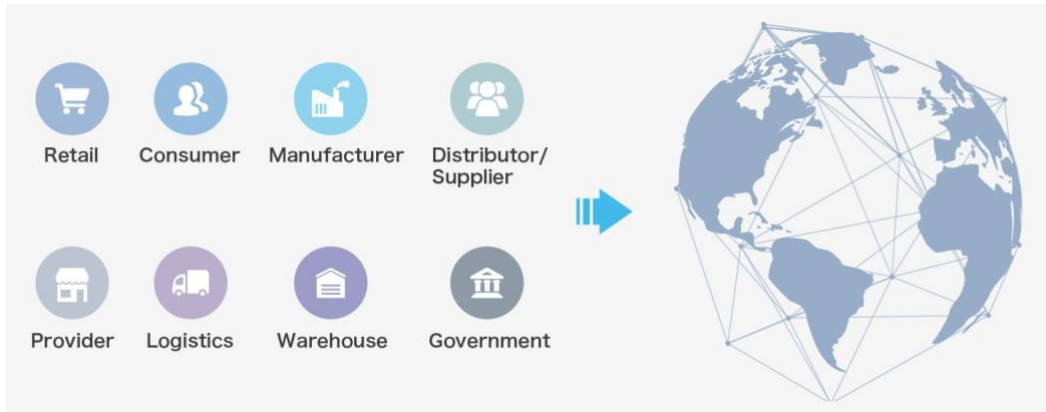

*Figure 5.1 Standard digitalization in the traditional world*

## 5.2 VeChainThor Architecture

The ground rule of VeChain technology development is to be driven by applications. We believe that use cases drive products and products drive technology development – NOT the other way around.

The path of VeChain's technology development is almost identical to and coupled with the development of blockchain technology itself. The initial idea was generated in the middle of 2015. From then on VeChain started with a series of technical proofs of concept (TPOC). Driven by demands from use cases and requirements of projects in different industries, technical delivery has been through several rounds of main iterations and many more minor iterations in the past three years.

If we consider the future VeChainThor ecosystem as a full functional freeway, the blockchain core network is like a road. Yet on this road there exist other services and functions such as toll-free gate, gas stations, rest stations, emergent lines and services, and etc. VeChain is not only building up a Blockchain core for a platform but also matching infrastructure services, public tools, and common applications to enable anyone to develop, deploy and use Blockchain applications in a convenient and professional manner.

From the application perspective, all business owners will focus on solutions rather than technology only. Therefore, the technical portfolio of VeChainThor covers other technologies than solely Blockchain, but rather includes open protocols to increase connectivity such as the Internet of Things, Artificial Intelligence and so on.

### 5.2.1 Four-layer Technology Stack of VeChainThor Platform

The four-layer technology stack of the VeChainThor platform is as follows:

**TouchingPoints:** these digitize the physical world. We use NFC and RFID chips to digitize products and sensors to capture environmental, inertial, gas and location information through sensors. TouchingPoints are VeChainThor's arms and eyes to connect to the world and collect data feeds.

**Connection:** the connection stack transmits the data captured through the sensor stack. These two stacks form the IoT technology portfolio in VeChainThor platform.

**Blockchain Core:** Blockchain Core is responsible for carrying on the transactions and storing the data gathered through the previous stacks. Smart contracts deployed and running on Blockchain enable the collaborative activities among multiple parties.

**Applications and Services:** Applications and public services built into the Blockchain provide the infrastructure services to simplify and standardize application development along with common protocols and interfaces such as VeVID for KYC, VeVOT for voting, VeSCC for smart contract certification, VeSCL for the Smart Contract Library and other suites of technical protocols like side-chains, cross-chains, data feeds, oracles and so on.



## 5.2.2 VeChainThor Platform Structure

The platform structure of VeChainThor is designed to be driven by business applications for use cases. The fundamental rules for this structure are:

- 1) Independent and derived technical layers;
- 2) Capabilities to be standardized, modulated, and flexible for fast iterations;
- 3) Convenient and fast development; and
- 4) Open protocols to other technologies and systems

Below is a figure demonstrating of the VeChainThor platform's overall structure:

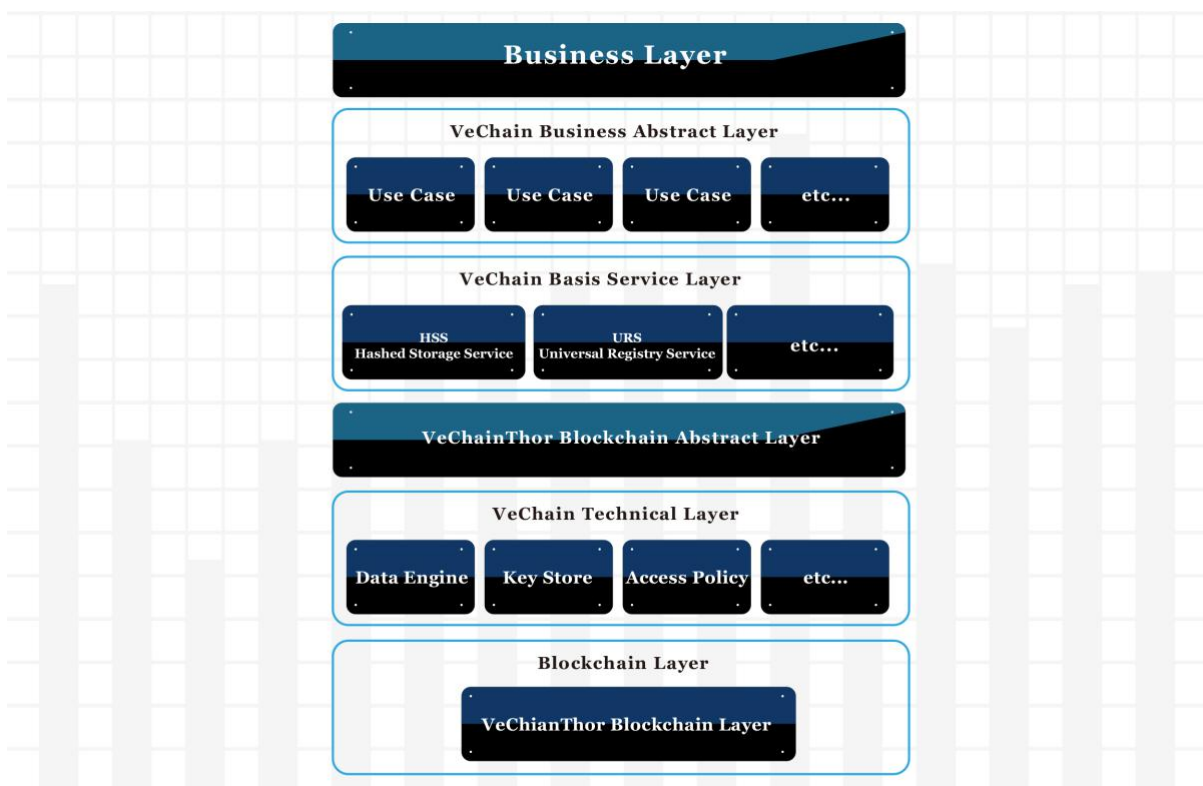

*Figure 5.2.2 VeChainThor platform structure*

There are two major layers – the blockchain abstract layer and the business abstract layer.

### 5.2.2.1 Blockchain Abstract Layer

The lower Infrastructure level includes the blockchain core including the following:

- 1) **Block Security Protocol (BSP):** BSP implements the signature function on each data block for the security of the Authority Masternode and PoA consensus. Only the data block with the authorized signature will be mined and accepted;
- 2) **Data Group Integration Protocol (DGIP):** DGIP can integrate data groups to Blockchain

by batch processing;

- 3) Layered Archive Protocol (LACP): LACP is for data storage with different layers to enhance the scalability and indexing of the data;
- 4) Multi Transactions Protocol (MTxP): operate multiple objects in one transaction that means one “from” can do multiple “to” in one transaction;
- 5) Distributed Cross-chain Communication Protocol (DCCP): DCCP is a cross-chain solution for data synchronization and interoperability between different Blockchain network;
- 6) Transaction Data Privacy Protocol (TxDP), TxDP ensures the privacy of the transaction and the data.
- 7) More to come.

The upper level is the smart contract abstraction layer. It is to achieve the technology abstraction in various scenarios and to build standard, modular smart contract templates to further combine and customize smart contracts for various industries, enterprises and use cases. Currently the Smart Contract Library contains VID registration, data binding, status data integration, digital ownership, ownership transfer, authorization declaration, authorization transfer, multiple authorization and so on.

The Smart Contract Library (SCL) is part of the infrastructure service suite of VeChainThor. We plan to launch the project with the community together to build and enrich the common, modular and certified smart contracts for developers to make business application development and smart contract development much easier.

#### **5.2.2.2 Business Application Abstract Layer**

The basic service abstraction layer is the lower level of this layer. Its purpose is mainly to build up the standard smart contracts for the basic service module including the Hash Storage Service, Universal Registration Service, and so on. In addition, this layer contains a public service module for the VeChainThor services including the index service for VeChainThor explorer, the Universal Data Audit Service of the audit node, the Blockchain Data Monitoring Service, the Distributed Content-Addressable Storage System, the Contract Name Service, the Data Grouping Service, the Privacy Information Protection Service, the Genesis Contract Service and so on. These public services along with the basic module can mitigate the difficulty and ease the entry of smart contract development.

We will continue to enhance this layer focus on developing more convenient tools such as a visualized smart contract development kit, more language support, a smart contract connector and so on. Using these tools, developers from different industries with different backgrounds and different expertise, or even developers with little blockchain experience can develop and deploy smart contracts easily for business applications.

The middle level is for the standard application interfaces for data interactions between the basic service level and the business application level. The key focus for this level is standardization for system interfaces with different business systems especially for the major widely used enterprise

systems or Internet platforms. We have built the interfaces with major enterprise application such as SAP, WMS and Salesforce, as well as common web and mobile application interfaces, and we will continue to enrich the stack.

The top level is the business application abstraction layer. It varies based on different business scenarios and applications. The developer of this layer is not even required to have blockchain development capability, but should know how to connect to VeChainThor Blockchain and call the smart contracts by standard protocols.

### 5.2.2.3 Architecture Breakdown

Driven by business applications and VeChainThor ecosystem establishment, the detailed technical architecture of VeChainThor Blockchain is designed as below:

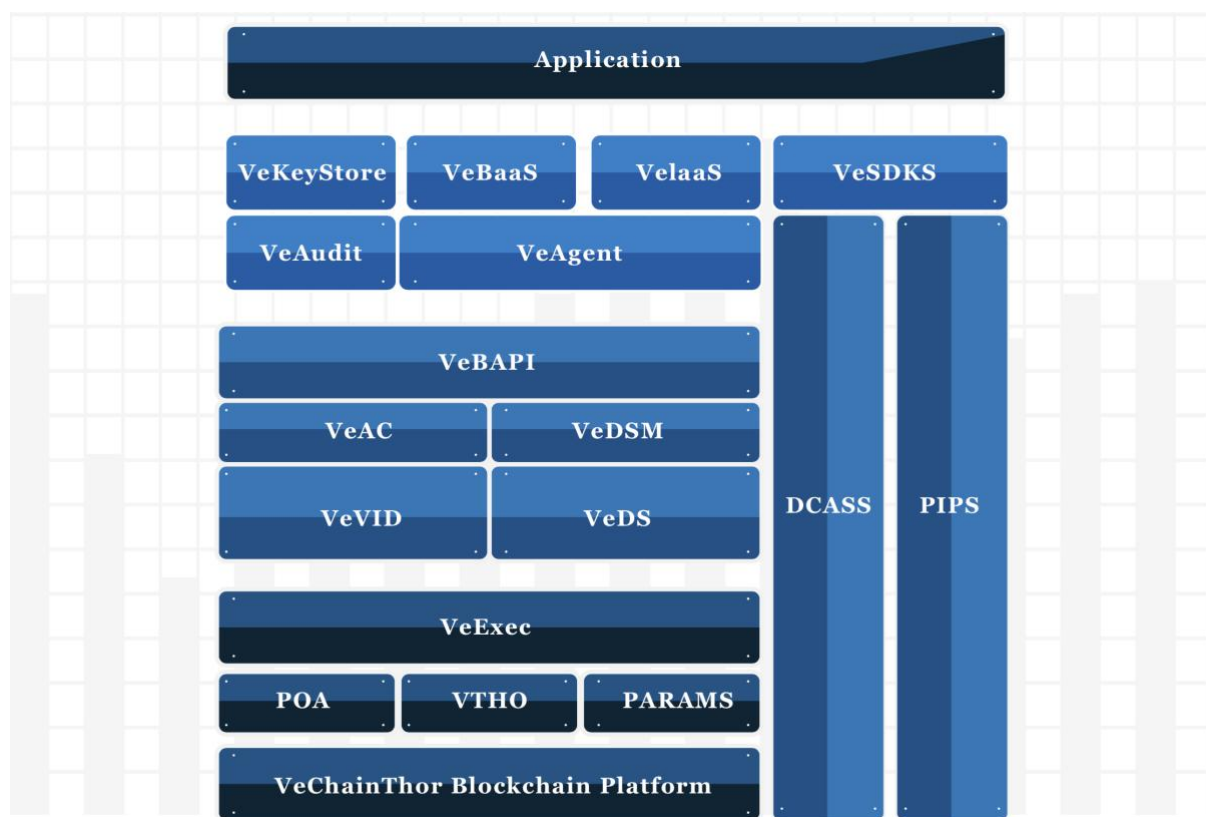

Figure 5.2.2.3 VeChainThor technical architecture

- VeKeystore – this is one of the public services for private key management in the application layer. Business users can have options to manage their keys by themselves or delegate to VeChainThor public services.
- VeBaaS – Blockchain As A Service on VeChainThor platform. This is a blockchain service management portal for business users. Each business owner is able to select or create their own Blockchain solutions based on the industry, business scenarios and demand.
- VeIaaS – Implementation as a Service on VeChainThor platform. This is the “one-click-deployment” module to allow business owners to deploy VeChainThor nodes with a predefined package in different clouds. We have engaged with some reputable cloud

providers across the world and will continue to increase our portfolios to deliver more options to end users.

- VeSDKS – Software Development Kit Suites of VeChainThor platform, including but not limited to the following:
  - ✓ VeSDKS.DB, SDK to integrate the traditional database such as mysql, oss/s3 from cloud providers.
  - ✓ VeSDKS.DCASS, SDK to integrate the distributed storage service of VeChainThor platform, the Distributed Content Address Storage System.
  - ✓ VeSDKS.Privacy, SDK for privacy protection which can be used in multiple business scenarios such as KYC application – VeVID. VeChain has been working with several reputable security service providers such as DNV GL to implement different options and solutions. VeChain plans to study and work on reputable open source solutions such as Bulletproof protocol from Stanford CSD.
  - ✓ VeSDKS.AA, SDK for access authorization can be used in the different access scenarios for smart contracts, data, files, systems and so on.
- VeAudit – a basic auditing service for the VeChainThor Blockchain network, smart contracts, transactions, etc.
- VeAgent – this is for interfaces to call smart contracts deployed and running on VeChainThor Blockchain.
- VeBAPI – this is original APIs to Blockchain.
- VeAC – Access Control for datasets and VeVID.
- VeDS – this dataset is for customized data storage.
- VeExec – the smart contract executor for the following smart contracts:
  - ✓ POA, management smart contract for Authority Masternodes including active list, standby list, signature control, and so on.
  - ✓ VeThor, the management smart contract for VeThor (VTHO) such as speed of generation.
  - ✓ PARAMS, parameters including the following:
    - 30% reward rate, adjustable;
    - 25,000,000 VeChain Tokens (VET) required to be qualified as Authority Masternode, adjustable;
    - gasPrice, for actual VeThor consumption for payment and smart contract transactions, adjustable;

- GrowthRate, adjustable.
- DCASS, Distributed Content Address Storage System.
- PIPS, Privacy Information Protection System.

## 5.3 More Technical Details

We can go deeper for more technical details for the functions used in use cases as below.

### 5.3.1 VID Generation and Hash Algorithm

VeChainThor Blockchain uses SHA256 Hash algorithm to generate VIDs. VIDs can be written into the IoT tags and devices such as NFC, RFID and QR code with our proprietary VID generator. For IoT tags, they may vary based on the products. They link the unique blockchain ID with the physical product. The IoT tags are designed based on the user's needs and feature of the product.

VIDs are hashed by SHA256 function which goes as follows: **SHA256(domain + '.' + ID)[12:]**. In this function the domain is the qualified name of table that the ID settled, for example **"com.VeChain.dbname.tablename"**

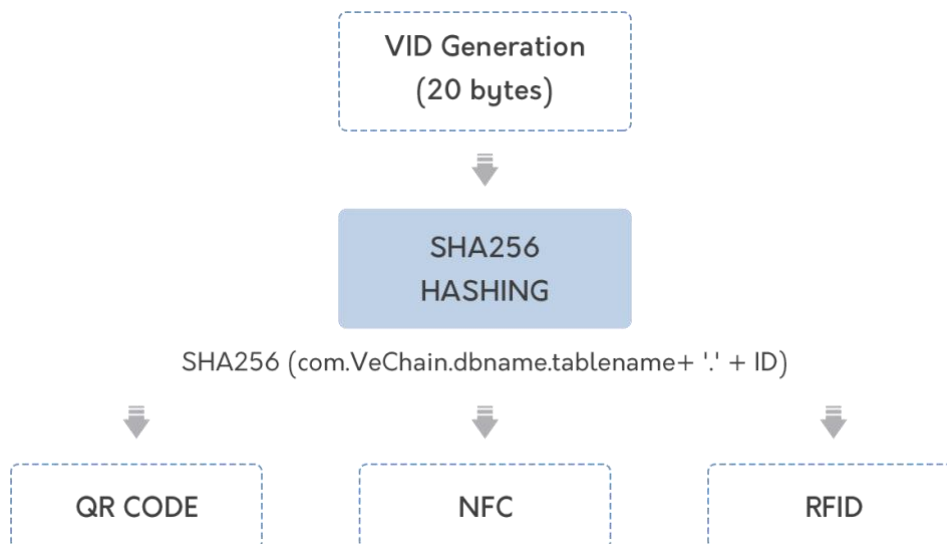

Figure 5.3.1 the creation of VID and hashing

### 5.3.2 Storage of VID on Blockchain

As previously mentioned, the hashed VID is written into a tag or tags depending on the client's needs. After the tags are ready, they go through a testing process and are "activated". Activation is done by using a custom-made software called "V-Operation" which can either run on mobile or desktop operating systems. Upon activation, the ID is then written into blockchain and broadcast to all blockchain nodes.

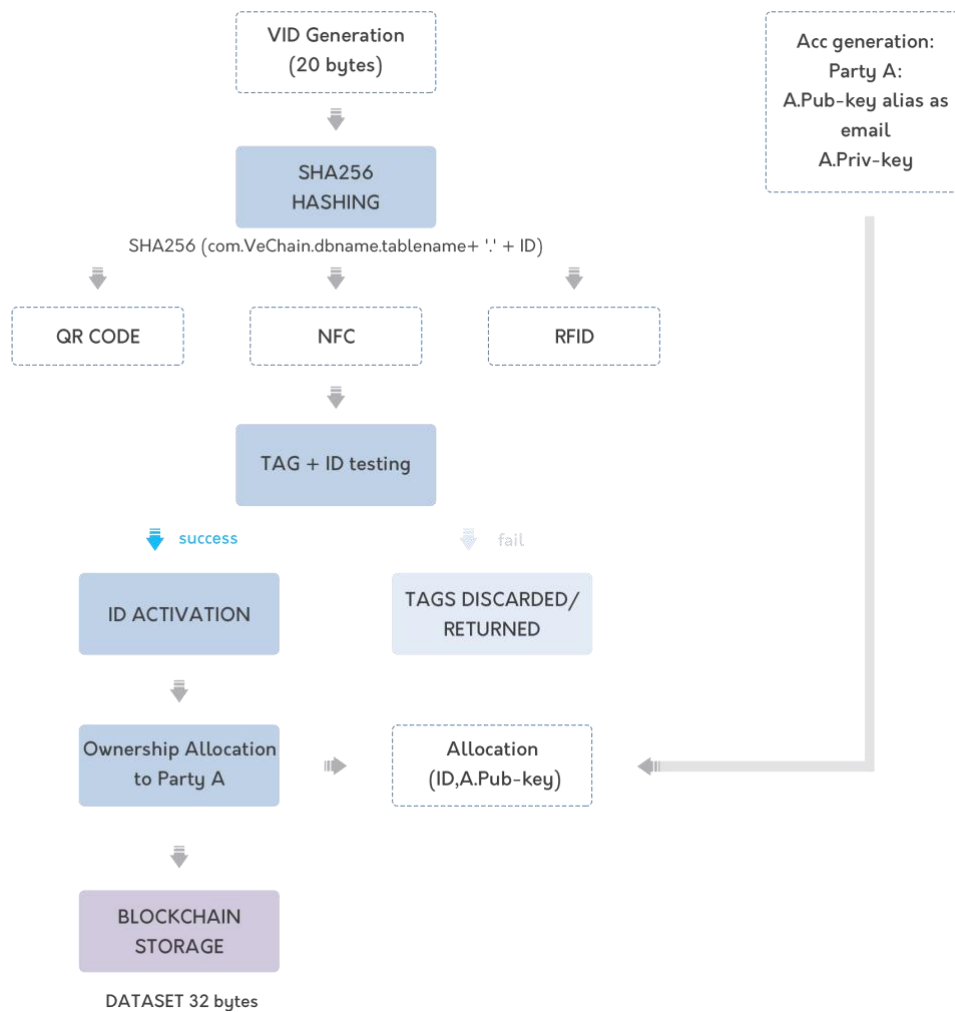

Figure 5.3.2 The storage of VID on Blockchain

### 5.3.3 Digital Ownership on Blockchain

VeChainThor Blockchain uses a tailor-made smart contract which enables **authorization-based digital ownership management**. The ownership of objects, represented by VeVID, is linked to an account with a public key and private key for each instance.

The public key is known as alias email address which can be recognized and accessed by anyone. The private key is to represent authorization and access, just like a password, to the objects with the corresponding public key. Authorization-based digital ownership management sets a specific link between the objective ID and the public key of owner who controls the corresponding private key.

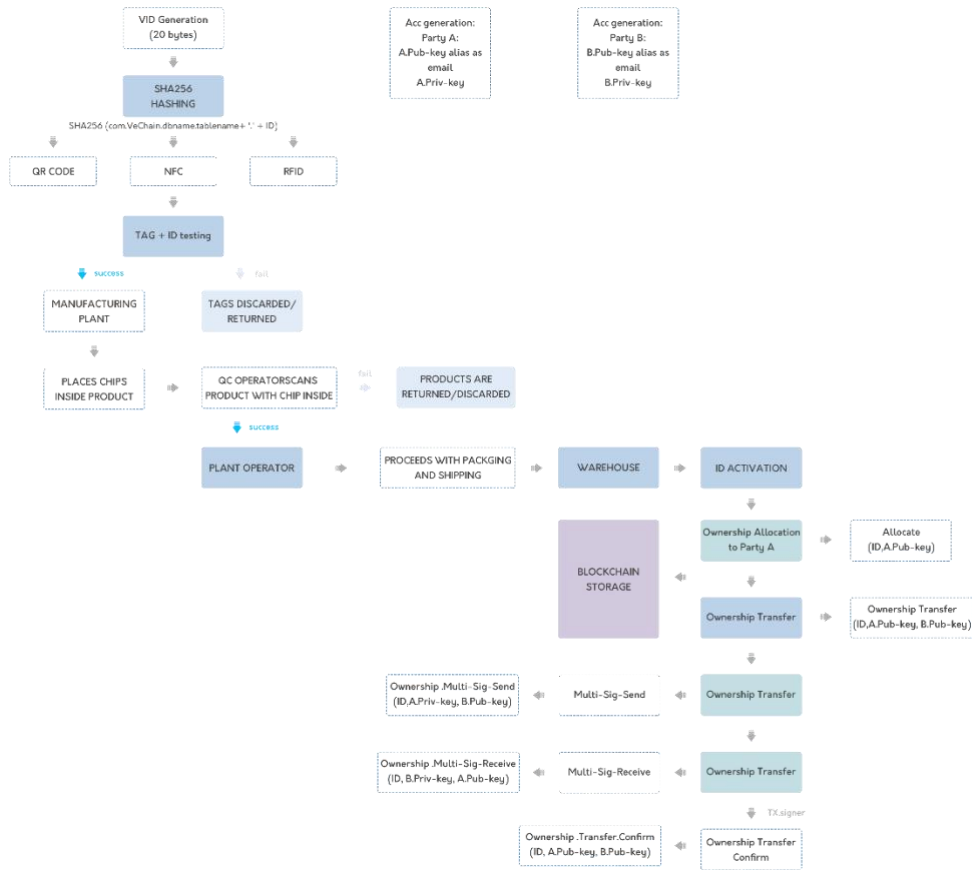

Figure 5.3.3 Digital ownership on Blockchain

### 5.3.4 Data Hashed Storage (proof of data)

VeChainThor Blockchain accepts any type of data: (strings, numbers, booleans, etc). Data is identified by its hash (SHA256). A sample for accessing data via RESTFUL APIs:

- **Store data**
- POST <https://domain/hss/>
- **Retrieve data**
- GET <https://domain/hss/{hash}>

The data is self-verifiable. When the data is retrieved, it can be verified by comparing its hash to the hash provided.



Figure 5.3.4 Data hashed storage



### 5.3.5 Standard API Gateway

The universal application architecture interface is designed for complex processes. The API gateway is the main entry for all API requests, it encapsulates the internal structure of the application and the up-level applications needed to interact with the gateway without calling a particular service. The internal structure of the upgrade or iterations happening in blockchain, smart contracts or services will be completely transparent. The applications do not need to concern changes in access, but to ensure that the exchange protocol is correct.

The following graph is the network topology, deployment and function of the API gateway.

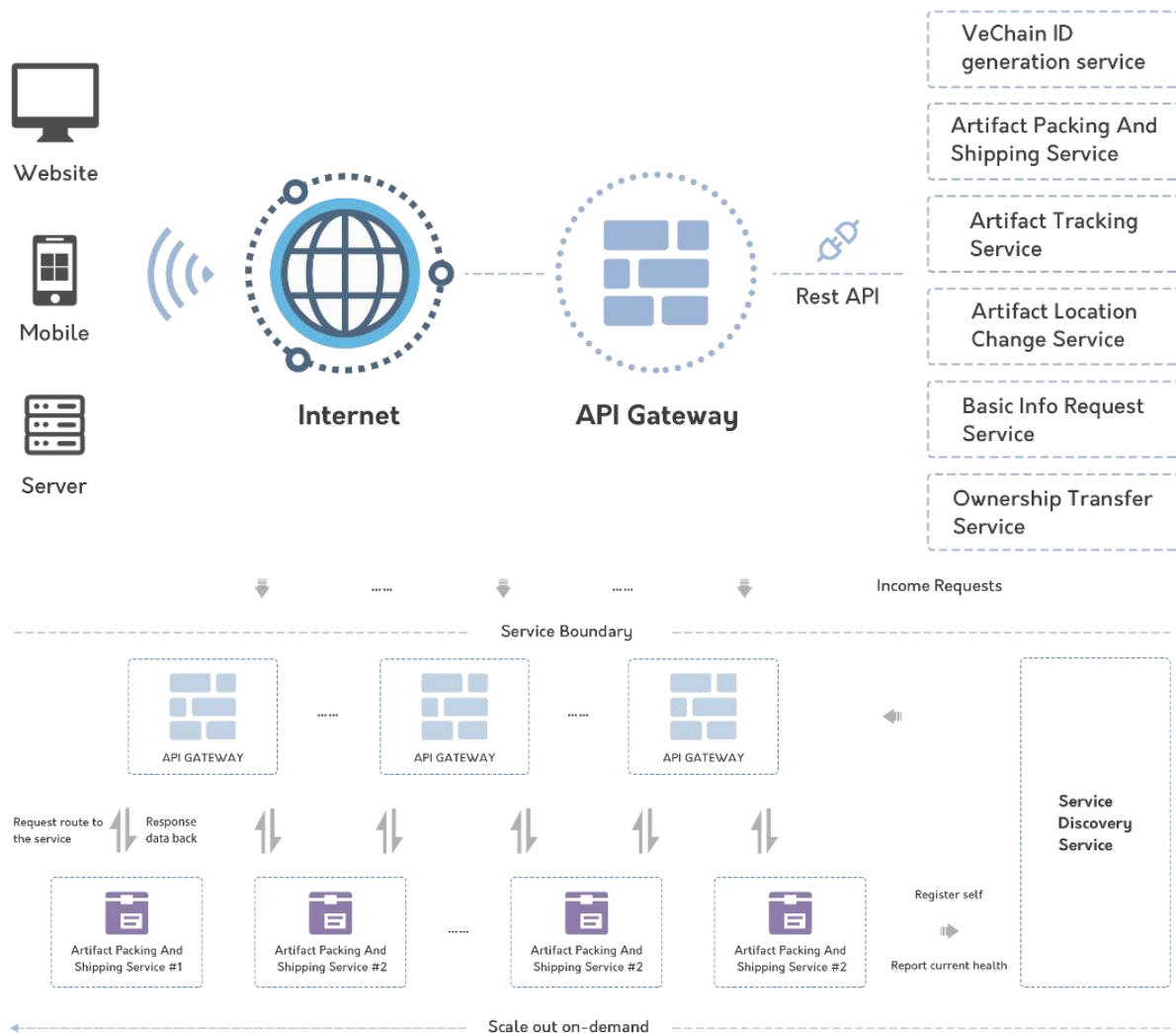

Figure 5.3.5.1 API Gateway-1

The resources of a server are limited. However, the design of the horizontal expansion makes it possible for large-scale access. Different instances of the same service can guarantee a service request shunt by the API Gateway. In the API Gateway we can use different access policies like consistent-hash, IP-hash, random access, priority access and so on. At the same time, the API Gateway and the Service Discovery Service also can be scaled on demand.

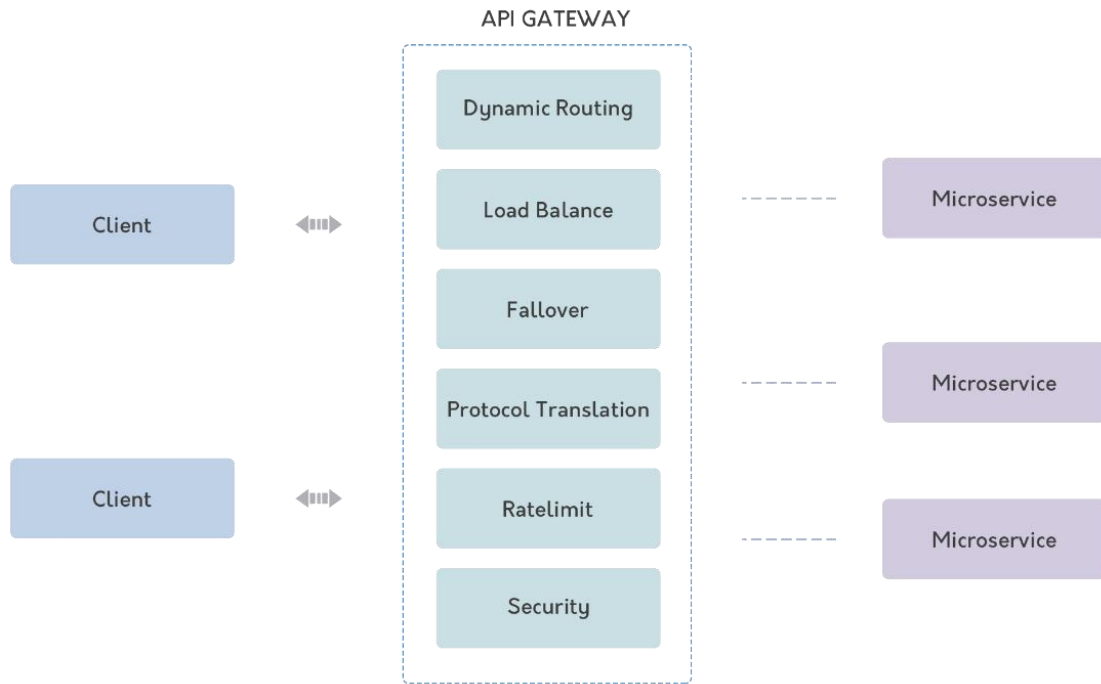

Figure 5.3.5.2 API Gateway

### 5.3.6 Service Discovery Protocol (SDP)

The API gateway needs to know the identifiable “address” (IP address and port) of each microservice that it communicates with. In traditional systems, locating and connecting to a specific address is difficult, and cloud based architecture makes it no easier. Normally, the infrastructure services have a static address defined by the variables of the OS environment. However, locating the address of an application service is not that simple due to dynamic distributions with automatic scaling or regular upgrades.

A service discovery protocol has two typical modes: client discovery mode and server discovery mode. The VeChainThor platform has chosen the latter. The user can initialize a service request through the API Gateway, and the API Gateway checks the service registry, and forwards the request to an available service instance. The advantage of the server discovery model is that the users do not have to focus on the details of the service but focus on the service request itself that simplifies the logical processes of the coding required by discovery services.

The service registry is the cornerstone of the SDP. Its function is to build and maintain a specific database that contains the addresses of the service instances. The service registry needs to maintain high availability and real time updates.

The self-registration mode applies to the service instances so that the login and logout of the service registry can be carried through the service instances. In addition, the service instance sends a heartbeat packet to ensure that the registration information is not obsolete. The ETCD is used to provide storage for private keys with features of high availability, distribution and consistency for configuration sharing and service discovery.

### 5.3.7 Micro-Service

The Micro-service represents all back-end services in VeChainThor Blockchain which can have customized configurations based on different requirements in use cases to ensure business isolation. The Micro-service can guarantee grayscale release of services (a smooth transition for new release of software and updates), allowing efficiency and speed of upgrades or rollback. In the API Gateway of the VeChainThor Blockchain, the Micro-service will provide the following functionalities:

#### Register & Unregister

The Micro-service will initialize the registration of the Service Discovery Service (SDS) when it starts and unregisters it when it shuts down. SDS can save the status of an instance for 30 seconds and will automatically unregister itself after that if the Micro-service does not execute when it shuts down.

#### Service Health Report

SDS is not supposed to know the status of instances running in the back-end. Therefore the Micro-service must report healthiness every 30 seconds.

Micro-services are more complicated than traditional services, especially regarding the communications between the backend services. SDS needs instances to register itself, therefore all instances need to follow the unified rules of registration. Third party registration services will be considered in the future which can be used to deploy Micro-service instances with configurations, check the health of instances and report to the SDS. By doing that, the Micro-service can be an application providing API services only.

### 5.3.8 Hashed Storage Service (HSS)

Hashed Storage Service (HSS) is a distributed storage service which can cover digital files, pictures, text data and any other object-oriented reliable storage. HSS is deeply coupled with the VeChainThor Core to ensure the security, integrity and privacy of stored data with proper ownership management and authorization management of data.

The HSS has two major parts: the data storage service and the operational storage service. The data storage service is responsible for external data storage, access control and authorization management; the operational storage service is responsible for computing the data storage path, the data subset and storage.

With the development of storage at large-scale, data needs to be backed up frequently for system reliability. Often multiple data copies are needed to ensure the availability of the data. This type of backup wastes storage resources and the cost will become more and more expensive.

A distributed storage system can lower the cost of traditional backup methods. With a distributed service, it can simplify the data backup program and therefore reduce disk space. It can additionally improve data availability and durability. Erasure code and Reed Solomon is also used in the storage system. Erasure code technology is mainly the use of a mathematical algorithm to verify the original data to achieve the purpose of fault tolerance. It can be used to reconstruct missing or corrupted data. Reed-Solomon (RS) code is a storage system that is more commonly used in an erasure code. Our Storage Service uses the RS algorithm to shard objects into parity blocks. Users can lose many drives (whether parity or data) and still reconstruct the

data reliably from the remaining drives.

In addition, HSS is also compatible with Amazon S3 APIs. As most developers are familiar with Amazon's S3 service and its API, HSS allows the calls of Amazon S3 API with low level data which reduces the cost of external data access.

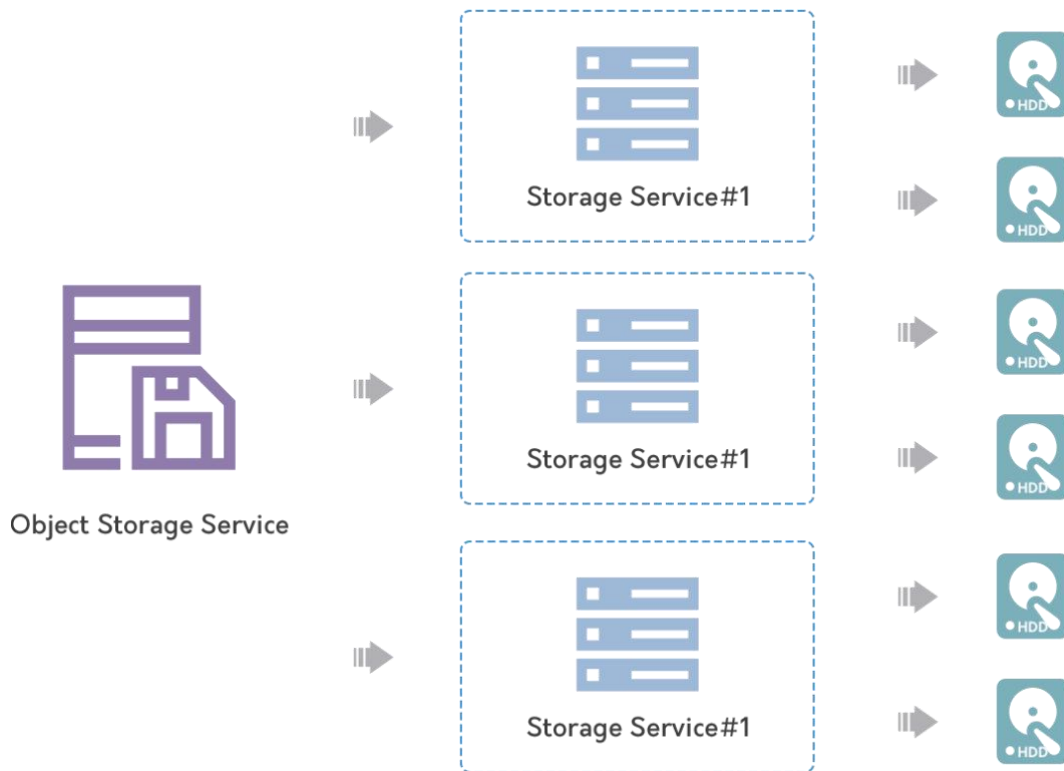

Figure 5.3.8 Hashed storage service

## 5.4 Blockchain and IoT

In 1999, the concept of the Internet of Things (IoT) was proposed by a British Scholar Kevin Ashton at MIT. After a number of interviews and discussions with a few executives from enterprise, Ashton defines IoT as:

*“A network containing all ‘smart’ devices with some sort of sensing mechanism that can communicate via the Internet with other smart devices or the cloud, without human interaction.”*

From the definition above, IoT has two key components – TouchPoint (Sensor) and Connection. TouchPoint is for the digitalization of the real-world either by tag technology to build up binding connections between physical objects and digital avatars, or sensor technology to collect key descriptive parameters such as environmental data, like temperature and humidity, and so on. Connection is for the channel and transferring protocol of information transfer such as Bluetooth, WIFI, 2G/3G/4G/5G, and so on.

The development of IoT will result in widespread adoption, multiple categories, high volume, rapid iterations, with progressively greater impact on all industries globally. In the coming years, the global growth of IoT devices is expected to be 15%-20%, and the International Data Corporation report shows the projection as 45 billion IoT devices world-wide by 2020.

### 5.4.1 Challenges of IoT Technology

IoT technology has existed since the 1990s. A landmark moment occurred in June 2016, when 3GPP announced “release 13” and defined the unified standard protocols of IoT connections. This solved the well-known four concerns of IoT:

- Limitation of number of connections;
- Limitation of coverage;
- Limited standby time; and
- High cost

After that, starting from September of 2016, mobile device manufacturers have started to release commercialized connection solutions of IoT for various applications, such as eMTC, NB-IoT and EC-GSM.

Through the major improvements for the four major challenges mentioned above, IoT development is entering the next level world-wide with prosper use cases, applications, products and solutions. However, there are another three serious issues for IoT which Blockchain technology has a strong chance of addressing:

- Fragmentation of the standard communication protocols;
- High cost of development, deployment and maintenance; and
- Data privacy.

### 5.4.2 Blockchain and IoT

There have been many explorations in IoT technology and generally smart systems on blockchain.

When blockchain is connected to IoT, it opens up numerous possibilities for innovations. Blockchain technology can help:

- 1) Record, track and validate the log history of devices;
- 2) Digital identification and ownership of devices;
- 3) The authenticity, privacy and security of devices; and
- 4) Smart activities between human and machine or machine and machine

We at VeChain believe that IoT technology and the Blockchain technology are born to be working together. IoT is the technology to build up informational and even commercial connections between devices which usually takes three steps:

- 1) Common communication protocol among devices means common language.  
This requires a universal communication protocol for devices, even those coming from different manufacturers and owners. This means that the devices have to communicate in the same language. The standards published by 3GPP provide a unified language for machine to machine connections;
- 2) Once the devices are able to talk to each other, the next step concerns universal identification for devices. This means universal IDs to be accessed and recognized by different parties, which cannot be controlled or manipulated by anyone. This is like a universal serial number but not limited to only one entity or one manufacturer. Blockchain is the perfect solution to build up this trust-free and consent mechanism among parties;
- 3) Based on the common language and universal identification, the devices can further collaborate and conduct business activities which will obviously require smart contracts and smart money to carry on.

Blockchain can ensure data integrity and IoT can ensure data objectivity when the data is collected and recorded to blockchain. As matter of fact, the three major high profile promising technologies are expected to work together:

- 1) IoT is like eyes and hands, responsible for touching the world and collecting the data;
- 2) Blockchain is like the heart to protect the data and trust;
- 3) Artificial Intelligence is like the brain, to process and analyze data.

### **5.4.3 IoT Development in VeChainThor Blockchain**

For most of business owners who are and will devote themselves to build up applications will prefer solutions other technologies only which usually are formed with integration of different technologies like Blockchain, IoT and A.I.

IoT is one of key technical capabilities of VeChain team. VeChain's technical portfolios include a dedicated IoT team focus on the IoT development and collaborative solutions with Blockchain

including but not limited to:

- 1) Tagging technology and encrypted chipset;
- 2) The identification of IoT sensor and data privacy;
- 3) Security and authorization module of NB-IoT.

Despite the complexity of IoT devices and applications, VeChain starts with the following categories of IoT devices with focus on:

- 1) By power supply:
  - **Active mode devices:** sensors, GPS, etc. with power supply
  - **Passive mode devices:** NFC, RFID, etc. without power supply
  - **Hybrid mode devices:** devices with limited battery and can be activated with external sources
- 2) By communication distances:
  - **Short range devices:** resolve the communication within 10 meters in distance, such as NFC (within 1 meter), RFID (within 10 meters), Bluetooth (within 10 meters), etc.
  - **Middle range devices:** resolve the communication within 1 kilometer, such as WiFi, sub 1g, lora, etc.
  - **Long range device:** resolve the communication with over 1 kilometer, such as NB-IoT.

Innovatively, VeChainThor Blockchain integrates device identity and asymmetric cryptography algorithm based on Blockchain to the traditional IoT portfolios:

- 1) **Device Identity:** every IoT device requires a unique and universal identity on the Blockchain network. This ID can be accessed and identified by all participants with authorization on demand in use cases. The identity additionally needs to be verified by specific smart contracts and applications such as modules in VeVID for devices to prove their original production and ownership.
- 2) **Asymmetric Cryptography Algorithm:** the asymmetric cryptography algorithm is one of the cornerstones of blockchain. Through a proper solution, the authentication and authorization of devices can be executed in a fully secure manner. Every device will be allocated with a public key and private key pair in which the public key is the identification and the private key functions as the security signature. In the design of VeChainThor Blockchain, the private key is stored in a safe section of each device, which is completely unreadable, while the encryption and decryption algorithm will be executed in the security mode of CPU or mCPU to guarantee its security. By implementing this solution, the use cases can cover accessing control of devices, device assurance, data source verification, smart contract execution control, and so on.

The following drawing is a sample of the chip design for NB-IoT Safety Module with VeChainThor Blockchain integration.

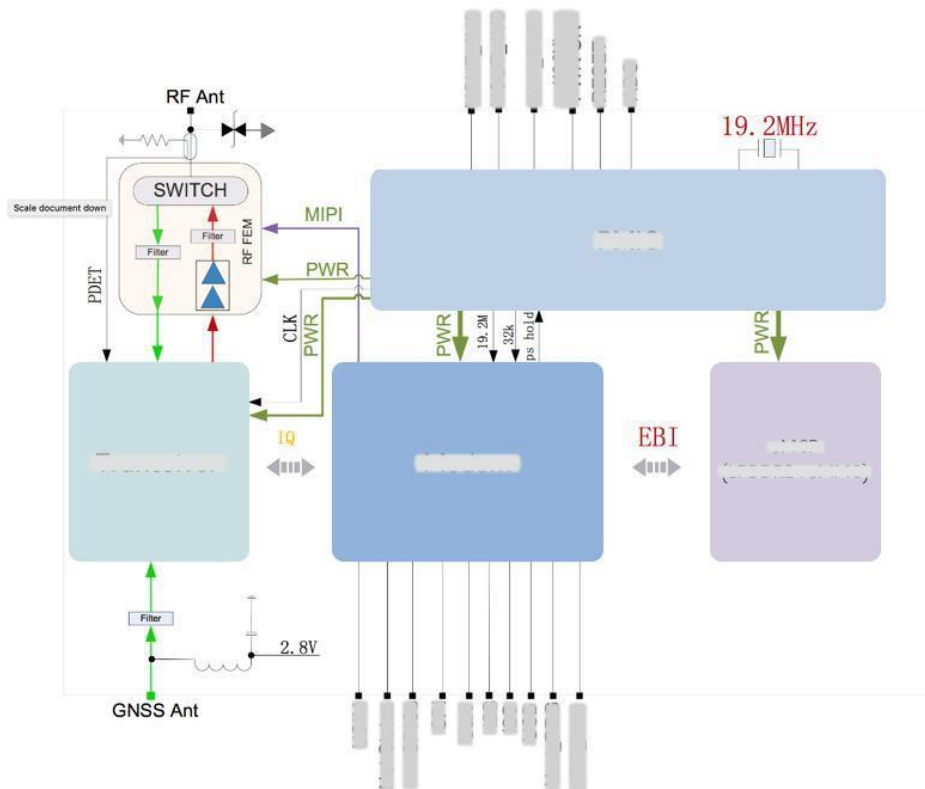

Figure 5.4.3 NB-IoT safety module



## 5.5 Technical Testing

VeChain evaluates the testing phase of any technical delivery by complying and following the well-defined procedures of professional software testing. Software should be predictable and stable to fulfil the expectations and design of the product. With constant development and the increase in complexity, intelligence and scalability of information systems over the last few decades, software testing has been developing and iterating accordingly. Testing theory and practice has evolved to be more and more systematic and mature with ever-greater impact on the software quality and its on-going running. Statistically, the testing work usually represents more than **50% of the time and cost** of a successful software project.

The fundamental question of software testing is this: in which subset can most errors or bugs be discovered and located? We can categorize the testing into three classic types:

**White-box testing:** white-box testing is also known as glass box testing or structure testing. The software under the testing is treated as a white box. The design of the testing cases is based on the internal structure and logic of what is to be tested. The tests are performed according to program paths and procedures including techniques such as control flow testing, data flow testing, branch testing, statement coverage, decision coverage, modified condition coverage, prime path testing, and path testing.

**Black-box testing:** Black-box testing is also called function testing. The software under test is considered as a black box. The tester must be aware of what the software is supposed to do but is not aware of how it does it. The test cases are built around specifications and requirements including techniques as decision table testing, all-pairs testing, equivalence partitioning, boundary value analysis, case-effect graph, error guessing, state transition testing, and so on.

**Gray-box testing:** Gray-box testing is a combination of white-box testing and black-box testing. The gray-box tester partially knows the internal structure of the software. This includes access to the documentation of internal data structures as well as the algorithms used. Gray-box testing usually is performed during the integration testing phase concerning not only the data accuracy of inputs and outputs, but additionally the internal conditions of software.

VeChain has established an independent testing team with roles and responsibilities of software quality management to ensure the software runs in accordance with its design. It must be emphasized that proper and organized documentation is vital element to the testing and entire development of VeChainThor platform and applications including but not limited to:

- 1) Master Test Plan (MTP);
- 2) Level Test Plan (LTP);
- 3) Level Test Design (LTD);
- 4) Level Test Case (LTC);
- 5) Level Test Procedure (LTPr);
- 6) Level Test Log (LTL); and
- 7) Test reports including Master Test Report (MTR), Level Test Report (LTR), Anomaly Report (AR), and so on.

VeChain has implemented comprehensive testing management rules for all technical development including Blockchain core, tools and services, applications, IoTs (hardware and software), and so on. There is no difference between VeChain and any other software project:

testing is a process of step-by-step convergence and VeChain testing strictly follows the circle of Plan-Do-Check-Act (PDCA).

**P (Plan):** this includes the confirmation of the testing plan that contains unit testing, integration testing, system testing (function, performance, safety and compatibility) and acceptance testing.

**D (Do):** perform the test based on the testing plan.

**C (Check):** summarize and report the testing results to the development team.

**A (Adjust):** the development team improves and fixes the codes accordingly.

The primary targets of VeChain’s testing includes:

- 1) Lower computer (PLC): Embedded software of IoT;
- 2) Client: PC, mobile (iOS, Android) and the other terminals;
- 3) Cloud & Servers;
- 4) Blockchain nodes, applications and databases;
- 5) Smart contracts;
- 6) Services; and
- 7) APIs

The following charts are demonstrations for some results of pressure testing of VeChainThor Blockchain:





Figure 5.5.1 Part of the pressure test data result. Testing environment is using the lowest cloud server configuration in different locations worldwide. The configuration is 2G Single-core CPU/4G Memory.

## 5.6 Technical Roadmap

The development of VeChainThor technology has been over two years in the making and the core guidelines have focused and will focus on three areas: applicability, standard and security.

There are a few sub-teams in VeChain Technical Department:

- 1) Research and Development – focused on the infrastructure level of the technology, as well as the research and experiment of emerging technologies such as IoT, A.I. and so on;
- 2) Development Delivery – develop and implement based on the driving of the Strategy Plan, Business Plan and R&D;
- 3) Blockchain Core;
- 4) Applications, Services and Tools;
- 5) IoTs – TouchingPoint and Connections;
- 6) Security; and
- 7) Testing, deployment and maintenance.

The roadmap of VeChainThor technical development stated below complies with the vision and mission of VeChainThor Blockchain:

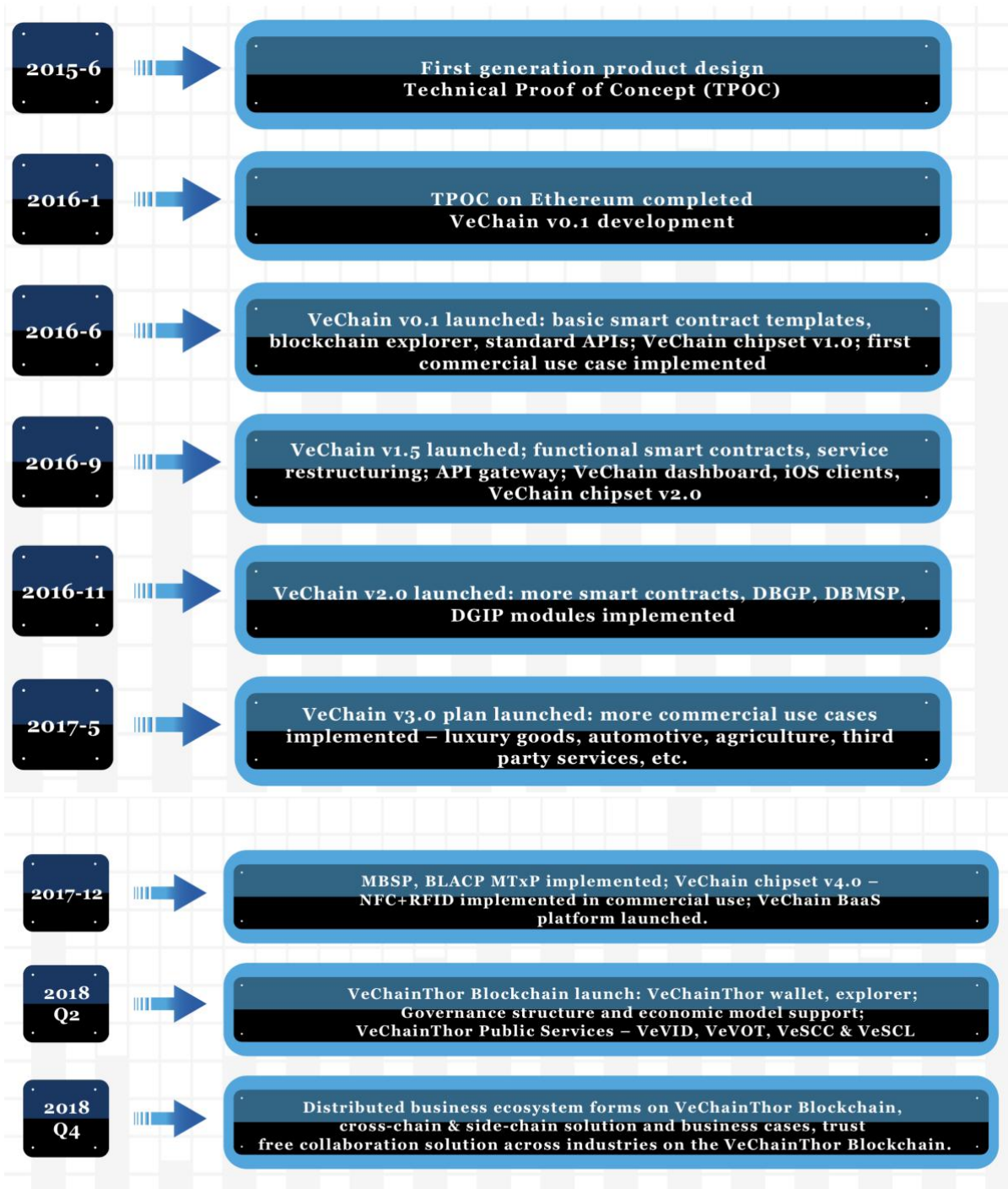

Figure 5.6.1 Technology development roadmap

## 6 Use Cases and Applications

Being a pioneer is very difficult. And being a pioneer all the time with passion and remembering why we started our journey is even more difficult.

VeChain started business engagement for use cases on Blockchain since early 2016 after the first-generation product and solution were built. In 2016 we began work on four use cases with major enterprises across the globe. In 2017, the number reached to over 20, including significant partnerships. Now, in early 2018, more than 210 opportunities are in the pipeline.

The market is growing rapidly world-wide. We are not alone and the growing community is becoming a significant force, working with the VeChain team to grow the VeChainThor ecosystem. Of the 210 opportunities in the pipeline, over half have arisen from community references. The community is an integral part of the VeChain team.

The ecosystem is and will be formed by applications and new connections like dots and links. The mission of VeChainThor Blockchain is to build and facilitate more and more applications with business values together with business owners. The VeChainThor platform will be the carrier for this, with robust core blockchain infrastructure, matching public services and tools, and devotion from everyone in the community including the VeChain Foundation, enterprises and individuals.

The figure below shows the VeChainThor application structure:

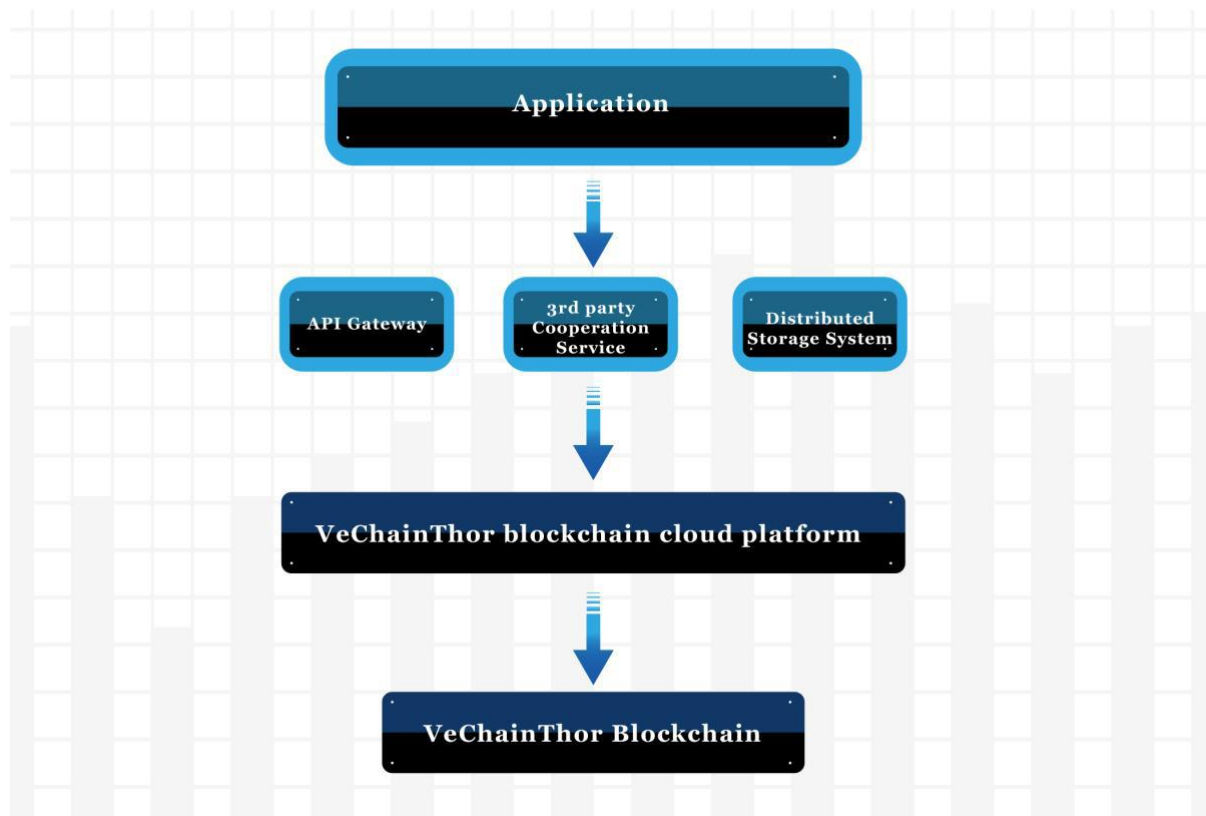

Figure 6.1.1 Industrial application structure

The VeChainThor platform will have an easy-to-use blockchain infrastructure for business owners and a “one-click” deployment solution so that they can easily build and manage their own





## 6.1 Fashion and Luxury

According to the fashion and luxury market survey for the year 2015, fake goods account for 9.7% of the total sales of fashion and luxury brands in Europe every year. Then add to this the \$2.87 billion spent on fighting against counterfeits. Fake goods have additionally caused the loss of 363,000 jobs in the fashion, manufacturing and retail industries.

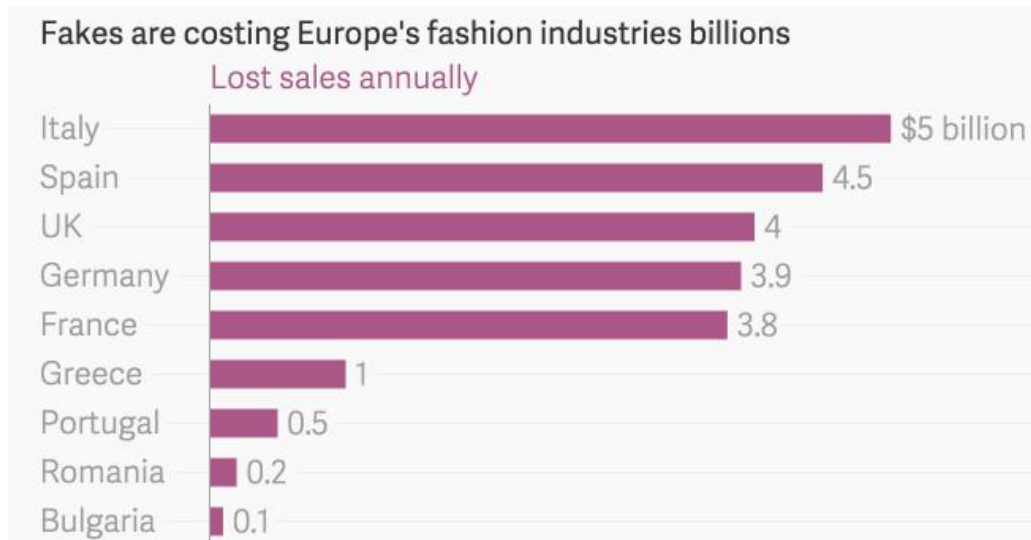

Figure 6.1.3 the impact of fake goods to the Europe fashion industries

VeChain's solution aims to build up a product traceability solution covering the life-cycle of products from the manufacturing, logistics and supply chain, retail and wholesale, after service, and even consumer engagement on blockchain for anti-counterfeiting along with IoT technologies. Fashion and luxury brands have already put our solution in place for live products and are enjoying the benefits of great reductions in counterfeit activities.

Every managed product is allocated with a unique VID presented by an IoT tag and registered on VeChainThor Blockchain which allows every player to access and recognize the same object in every step of its life-cycle. This solution is particularly effective because it simplifies the operation processes for each step by optimizing existing ERP systems like Production System, WMS, SAP, and Retail Systems with APIs connected to blockchain. This reduces the overall cost of delivering the product.

- 1) The manufacturer, most of time the third party supplier, establishes the physical connection between product and tag with production information records such as location, time, raw material, craft, quality check, and so on;
- 2) The brand owner can control the smart contract for VID registration to "activate" the product officially after the quality check and acceptance to eliminate the possibility of overproduction;
- 3) Data from logistics and supply chain operations can be recorded on blockchain through APIs from WMS and supply chain systems;
- 4) Retail systems can perform ownership transfer by calling a smart contract during the



selling process to end users just like sending an email;

- 5) Consumers can claim digital ownership and engrave a personal signature to create their own story;
- 6) After service, CRM and digital experiences all can be improved and shaped by building up a unique and customized bridge to consumers with privacy protection and consumer consent.

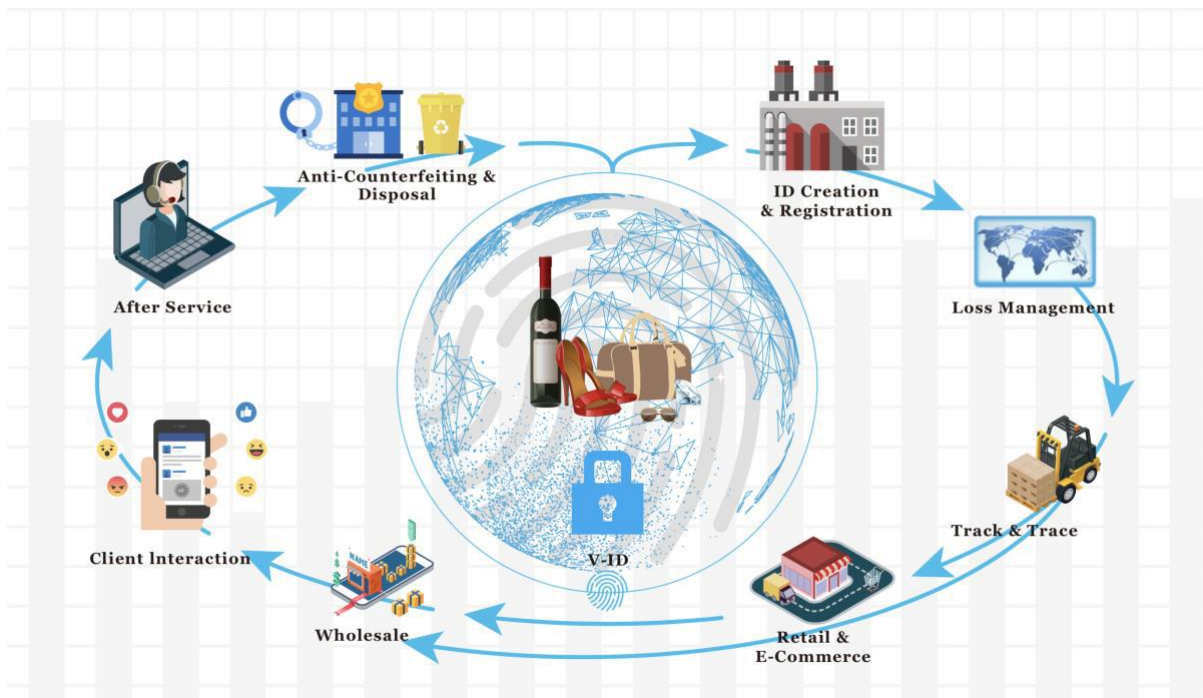

Figure 6.1.4 Lifecycle of luxury and fashion products on VeChainThor platform

## 6.2 Food Safety

Food safety is one of the most pressing social topics worldwide. The traditional solution for food safety relies too much on process control and the social responsibility of enterprises. It is difficult to track, trace, log, and locate food in the supply chain, and accordingly it is hard to identify if any problem has occurred.

Yet blockchain technology could bring safe and reliable solutions to the food industry. The Chinese government has announced and reinforced that food certification and effective tracking through the supply chain are the key factors to finding and eliminating sources of pollution in the fastest possible way.

### 6.2.1 Oversea Liquor Tracking Platform for D.I.G

**The Oversea Liquor tracking platform** for D.I.G., built on VeChain, can track wine from the very beginning of the process, including from when the bottles were still in the overseas winery. D.I.G. is a subsidiary company of the state owned company managing 30% of the imported wine market in China, WaiGaoQiao group, listed in the main board of Chinese Stock Exchange as 600648. This is the first successful Blockchain use case in production in China. Every detail about the bottle of red wine is marked and recorded at the beginning of the process. This way the regulator and D.I.G can use a smart contract to track the whole life period of the wine and log the ownership management, from the overseas winery, export, import, inspection, warehouse in the free trade zone, the distribution center and finally to all the different sales channels and retail stores.

Customers can identify and check information about the wine through in-store touch-screens or by smartphone. High-end wine can be equipped with IoT Chips for added safety and convenience. VeChain's IoT team has designed the chipset as a "sticker" or "seal" to prevent wine that has been consumed and refilled being registered as authentic. Through using the VeChain mobile app on a smart phone which supports NFC reading, available on both iOS and Android, users can easily check the product information by scanning the bottle.



Figure 6.2.1 VeChain application in the wine Free trade zone: background management system, smart front terminal, mobile showcase

This project has been awarded a strong chance of promotion by the national program organized by the Shanghai Municipal Commission of Commerce as one of the standard solutions for tracking liquor from Shanghai to the whole country.

### 6.2.2 MyStory

MyStory is an off-the-shelf blockchain based digital assurance solution for the food and beverage industry combining deep industry expertise of prominent industry leaders and DNV GL, with independent physical audits, data collection, and verification services.

The Italian wine sector is the first to use MyStory working directly with four wine producers, Michele Chiarlo, Ricci Curbastro, Ruffino and Torrento who have partnered and

collaborated with VeChain and DNV GL on this disruptive solution. These industry leaders will feature the MyStory label on their bottles in stores, using the VeChainThor Blockchain solution and hardware tags, by the end of the year.



Figure 6.2.2 MyStory application on VeChainThor platform

*“MyStory illuminates products and their supply chain for the benefit of consumers, who will have instant and in-depth access to key product characteristics such as quality, authenticity, origin, ingredients, water and energy consumption and more, all verified by DNV GL along the entire transformation process,”* says Luca Crisciotti, **CEO of DNV GL – Business Assurance**.

The MyStory solution will not be a stand-alone application for the wine industry but will transcend this, to be an application accessible across a wide variety of markets.

### 6.2.3 Cold-Chain Assurance Solution

Along with our global collaboration partner DNV GL, VeChain is building another food safety solution coupling with IoT sensors: a Blockchain-based cold-chain assurance solution, starting from a global convenience store franchise, NDA protected.

With the cold-chain logistics assurance service, each customer can quickly check the logistics information for the fresh products, from the food factory, through the cold-chain logistics provider, cold storage in the store, and ultimately on the shelf to be sold.

**From the perspective of our technology**, VeChain utilizes its in-house advanced IoT devices to monitor, record and upload temperature, humidity and location data to the VeChainThor Blockchain on a real-time basis. This solution is made possible as DNV GL ensures the cold-chain logistics process to fulfil food safety-related regulation and compliance **in**

**business processes.** Only with VeChain Thor would DNV GL be confident that the next generation of digital assurance services are unbiased and assured. Cold-chain logistics is an industry VeChain can thrive in and it is one of the many that DNV GL will guide us into.

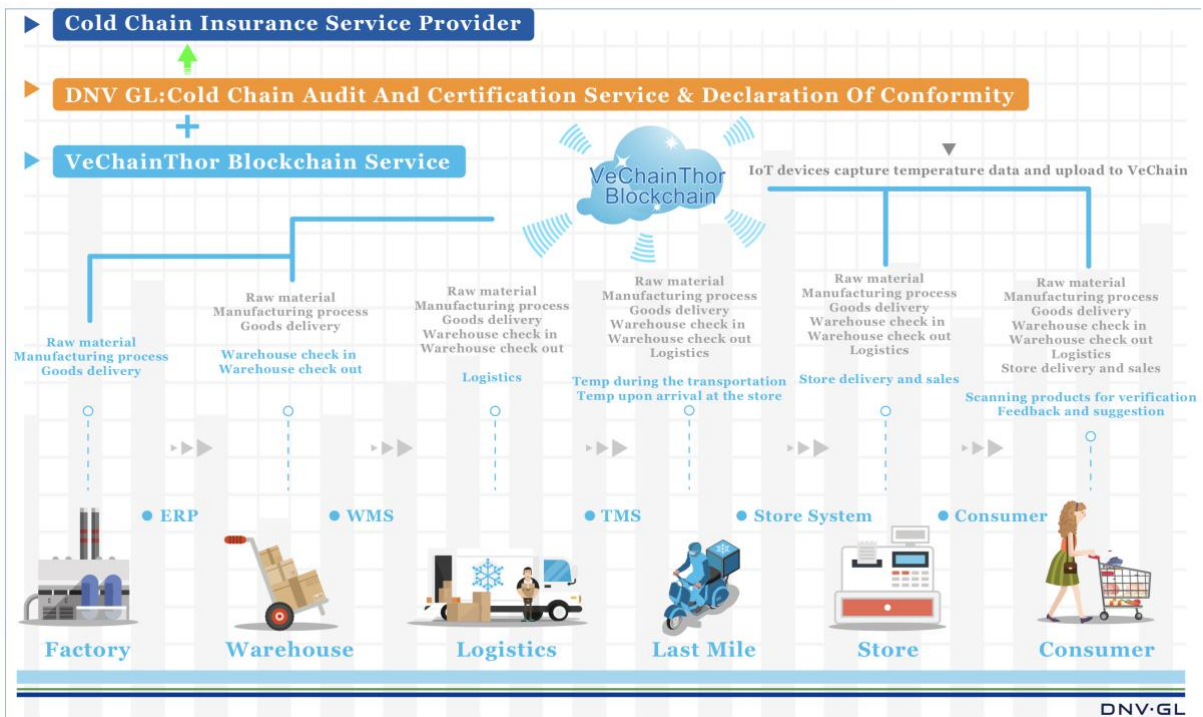

Figure 6.2.3 VeChainThor cold-chain supply chain solution co-developed with DNV GL

## 6.3 Automobiles

The automobile industry is a complicated ecosystem with many players including manufacturers, distributors, 4S shops, agents, regulators, financial service providers (insurance, bank), technical experts, and so on. In the lifecycle of a vehicle, a large portion of the “user data” is never owned by the consumer or car owner, while these data are stored in fragments by different participants instead. The value of those data is significantly lower than it could be due to such fragmentation.

VeChain has worked with business partners Viseo and Microsoft France to initialize the vehicle passport project. In the project, the VeChain team is responsible for completing the blockchain deployment on Azure, developing and deploying smart contracts and providing standard API to the upper level applications including:

### 6.3.1 Digital maintenance logs

Every car can build their own digital record with the authorization of the data owner. After the car owner has bought the car, they can use authorization and non-authorization features to give permission to maintenance service providers such as 4S shops or workshops. Different players will record their own data along with each service and transaction protected by VeChainThor Blockchain. The data gains much more value once the fragments have been put together with proper authorization control and economic incentives.

Data users like insurers or banks can easily conduct an inquiry of the automobile information and historical logs using the authorization from car owners which can be trusted since the data comes from different players in the system of services, and because the data has a hash copy on blockchain to verify the data integrity

The traditional due diligence required during insurance renewal or second hand trading will yield great improvement in terms of efficiency and cost.

### 6.3.2 “Green Driving”

The second module built on this application is to record the driving data from car computers to Blockchain, such as acceleration, average speed, gas consumption and so on, to motivate everyone to improve driving behaviors. Those data protected by blockchain can contribute to the inspection and valuation of the vehicle. Those user activities can be linked to personal credits and other corresponding activities such as carbon emission reduction.

Blockchain makes it possible to trust the collected data. This allows the value of the data to be created, applied, transferred and distributed based on the new business model.



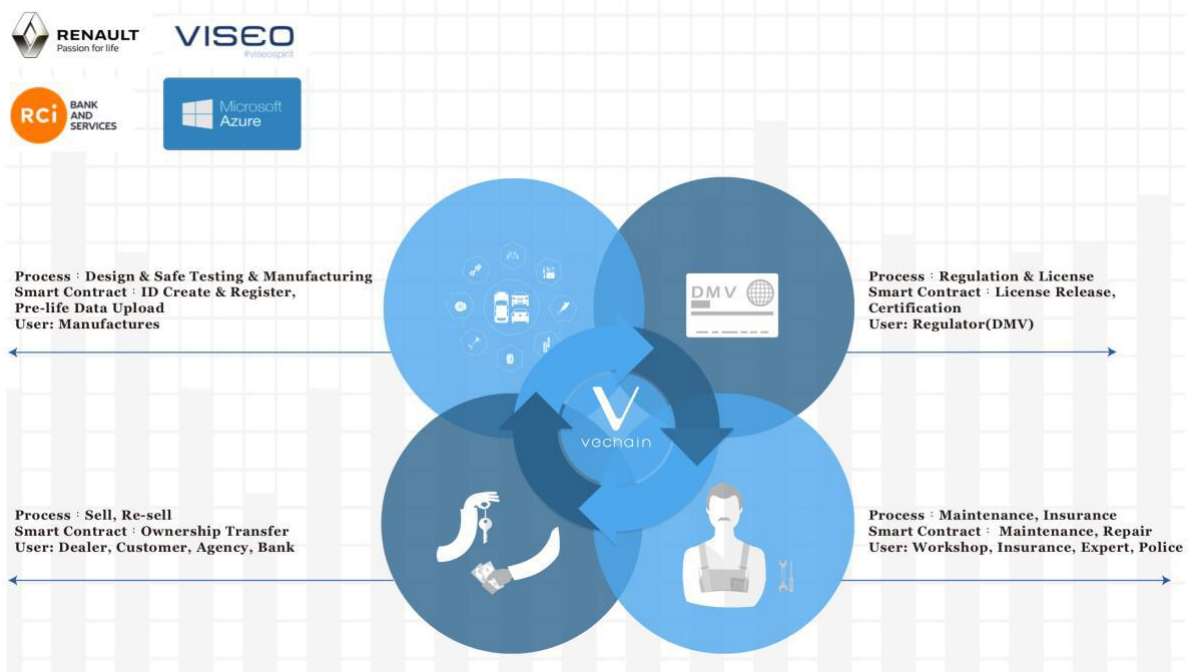

*Figure 6.3.2 VeChainThor Automobile application developed for Renault*

BMW, as our new partner, is building up another solution on VeChainThor platform. More details will be announced directly from BMW later once it is ready to go.

## 6.4 Supply Chain

Traditional supply chains include: original material supplier, manufacturer, service agents, logistics, regulators like custom and inspection, storage, retail and finally customers.



*Figure 6.4-1 Traditional supply chain*

Traditional linear supply chains have been conceived to deliver reliable and cost-effective results. Transactions (physical, informational, financial) normally take place between two players in the supply chain who come into contact during the process. Supply chain stability is a trust element in itself. As a natural consequence, relationships between different players are long lasting. As such, selection of the right partner is the key factor in success.

With the development of business and technology, supply chain nodes are starting to be more and more interconnected by technology calling for new forms of collaboration and transactions which create efficiency and value in trade. These new forms of collaboration and transactions are generating a need for new level of trust among players which were rarely in touch before. Furthermore, users and consumers need more trust for the products or services they are expecting, which increasingly require nodes in the supply chain to link with each other.

A new form of supply chain is coming with the following features:

- 1) An exponential increase in different transactions among multiple players;
- 2) The digital content of products and services is increasing;
- 3) Sophisticated “pay per use” business models will arise: players need to trust that “we pay for what we receive and earn from what we share”;
- 4) The ability to find smart and cost effective ways of tagging physical products and connecting them to digital avatars will be a crucial competitive advantage; and
- 5) Collaboration and transactions may happen among machines other than humans.

Blockchain and IoT are born to construct this new type of supply chain.

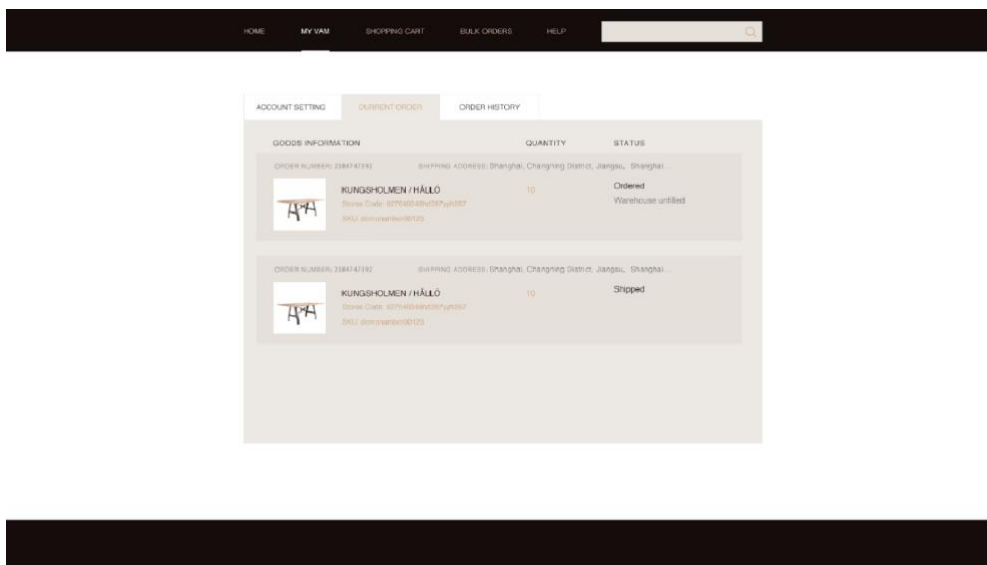



Figure 6.4-2 VeChainThor platform is for new mode of supply chain

### 6.4.1 Asset Management for Kuehne + Nagel

VeChain provides Baas (Blockchain-as-a-service) service to one of the biggest freight forwarders, K+N, to track and manage all the products from reputable enterprises. To ensure data protection and privacy, VeChain completes the connection with different customers through a common service platform. The operation staff can complete related business work by directly using the handheld terminals.



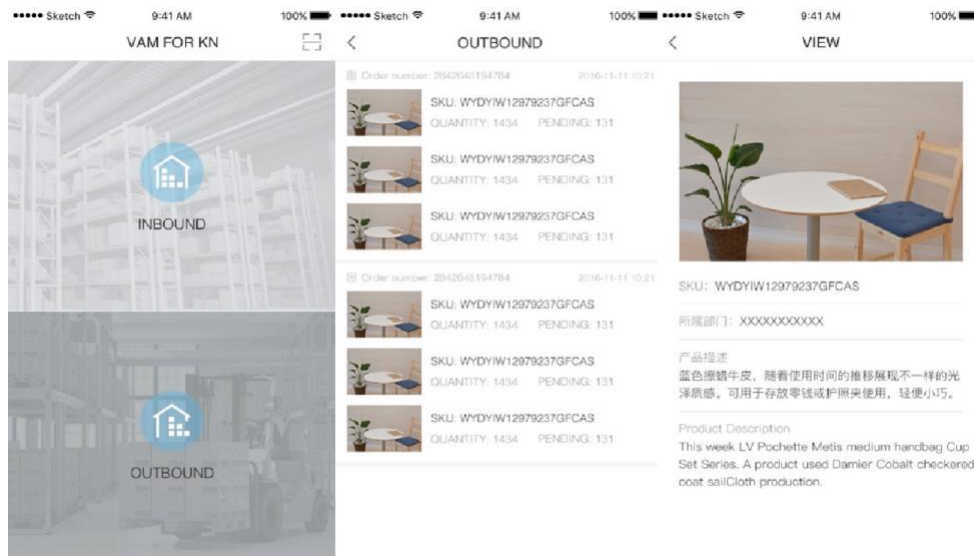

Figure 6.4.1 The showcase of our logistics issue solution by freight forwarders K+N

At a later stage in the plan we will make connections with more related cooperative partners, service providers and regulators.

#### 6.4.2 Supply Chain Risk Management with LogSafer

VeChain and LogSafer are partnering to develop a blockchain solution for logistics insurance. Cross-border logistics management is a complex business model. There are many layers to different businesses that get involved when a product is shipped from point A to point B. These layers become exponential in difficulty when the products have to cross borders. Many variables in business activities lead to risks within issuance underwriting – LogSafer is the expert for this risk management service.

In order to offer better insurance services to clients, LogSafer will require untampered true data as quickly as possible to make accurate claims payouts as well as improve the client's entire risk management system upon review offering a more valuable proposition to clients in the future. The VeChain solution adds value across the entire industry by helping LogSafer to better identify the various risks faced within each link in cross-border supply chain, take appropriate preventive measures to reduce risk probability, provide appropriate insurance product transfer risks and carry out efficient claims recovery after the risk.

Blockchain technology allows multiple parties to participate in recording data that cannot be tampered with. Using the unique VeChainThor Blockchain and IoT technology, enterprises can better track risk and record verified data. The solution allows companies to master the latest risk dynamics within their supply chain as well as research and explore better alternatives with the verified data. This advantage can save the creation of millions of documents associated with data collection and verification in the payment link, substantially reducing the payment review time. The realization of smart contracts within this industry will genuinely bring “instant compensation” for companies producing a much more profitable business model. This is the ultimate experience for the insured and is most profitable for all parties.

Example: a fish farmer sends a cargo of fish from Japan to California, and buys an insurance policy from our partner LogSafer to cover this cargo of fish. Something happened en-route and

the data grabbed from the VeChain sensors strategically placed within the fish cargo had indicated a high temperature reached and an extensive exposure period, meaning that it was impossible for the fish to stay fresh. VeChain sensors retrieve that data and upload it on chain. The state of the data triggers a smart contract execution, then the client automatically files a claim and receives a payout by the insurance company.

## 6.5 The Agricultural Industry

The Chinese market is facing many critical issues in agriculture. This includes the scale of the agriculture which is too small and separated, the quality of product which is uneven, the lack of safety of the product, low productivity and environmental pollution. It is hard to fix the issue by simply using a technology from the Internet or a law or regulation provided by the government. We believe that we can help change the way of thinking by providing our blockchain cloud project designed to verify that agriculture is green and organic.

China is promoting its Agricultural Cultivation Management Plan by using IoT technology, agricultural planting process management, blockchain technology, big data and AI (artificial smart) to complete the management of the process before, during and after agricultural production. In this way, good currency drives out the bad to achieve a standard agricultural market.

With this in mind, VeChain is cooperating with PwC, China Unicom and Liaoning Academy of Agricultural Sciences to develop a blockchain cloud project exclusively for the verification of the green organic agriculture.

In this project, VeChain has registered each greenhouse in every farm by using blockchain technology to build a data model to record the functional data of every greenhouse. The data source has two main parts: the first part is the production operations data which is recorded by the farmers directly; and the second part comes from the IoT sensor in the greenhouse. Based on the combination of the data and risk assurance service from PwC, it will establish the foundation of trustworthy data for the verification of green agriculture by the Academy of Agricultural Sciences. In addition, with the support of IoT equipment, efficiency of farm work is improved by about 9 times.

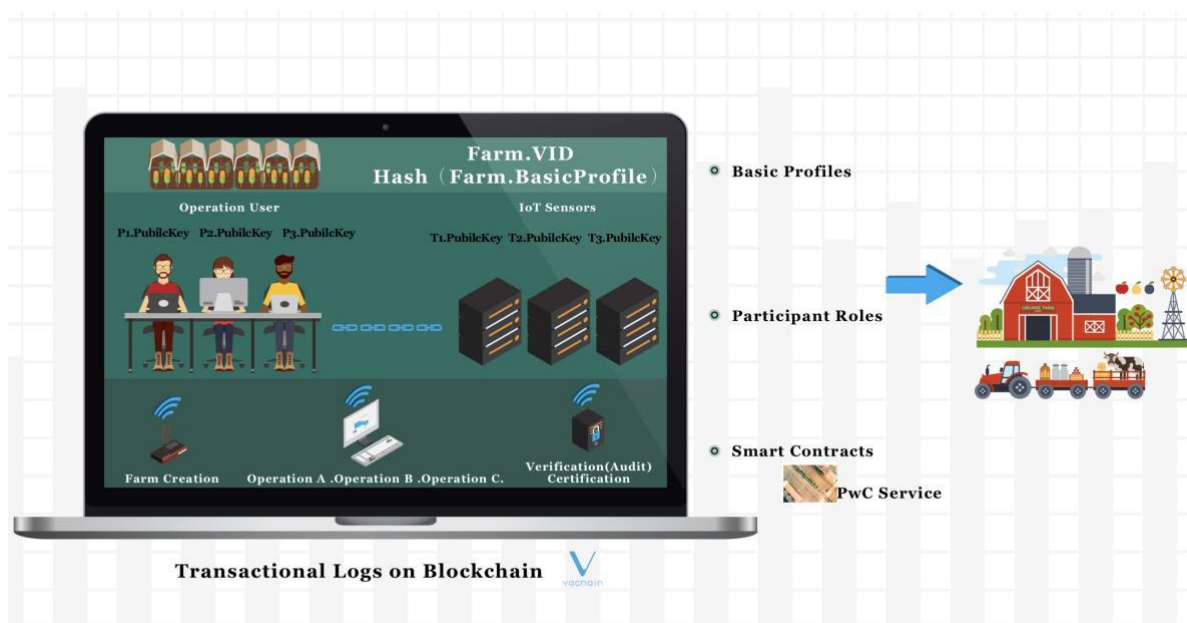

Figure 6.5 Application of agriculture combines with IoT technology

## 6.6 Government Affairs

Government departments show great interest in blockchain technology world-wide. The Chinese Ministry of Industry and Information Technology has released a white paper about the application and development of blockchain technology. The State Council underlined that blockchain can deliver a world with trust.

The UK Government Office for Science has reported on the potential qualities and advantages of blockchain technology in its recent report ‘Distributed ledger technology: beyond block chain’: “Distributed ledger technology has the potential to transform the delivery of public and private services. It has the potential to redefine the relationship between government and the citizen in terms of data sharing, transparency and trust and make a leading contribution to the government’s digital transformation plan.”

VeChain is partnering with the Administrative Examination and Approval Bureau of Gui’an New Area to provide a blockchain based information system to collect and analyze administrative data, offer privacy protection of data and to apply blockchain technology to reform business registration and cut red tape.

- 1) The Administrative Examination and Approval Bureau of Gui’an New Area can use the E-Government System powered by VeChainThor Blockchain technology to store business registration related documents, such as business certificates, bank account certificates, tax registrations, organization codes, foreign trade registrations, audit reports, etc.
- 2) For phase two of the project, the E-Government System will allow remote business registration functionality, document uploading, document review and certificate issuing to be done remotely. With this new system, companies do not need to waste time and energy to get physical stamps of approval from different governmental departments. This process disrupts the way the government processes administrative requests, becoming more collaborative while reducing cost and time spent.
- 3) The end result of the E-Government System will provide robust auditing over all government processes occurring within Gui’an, and future projects.

For example, due to the lack of collaborative data, the current entrusting party cannot query custom required documents.

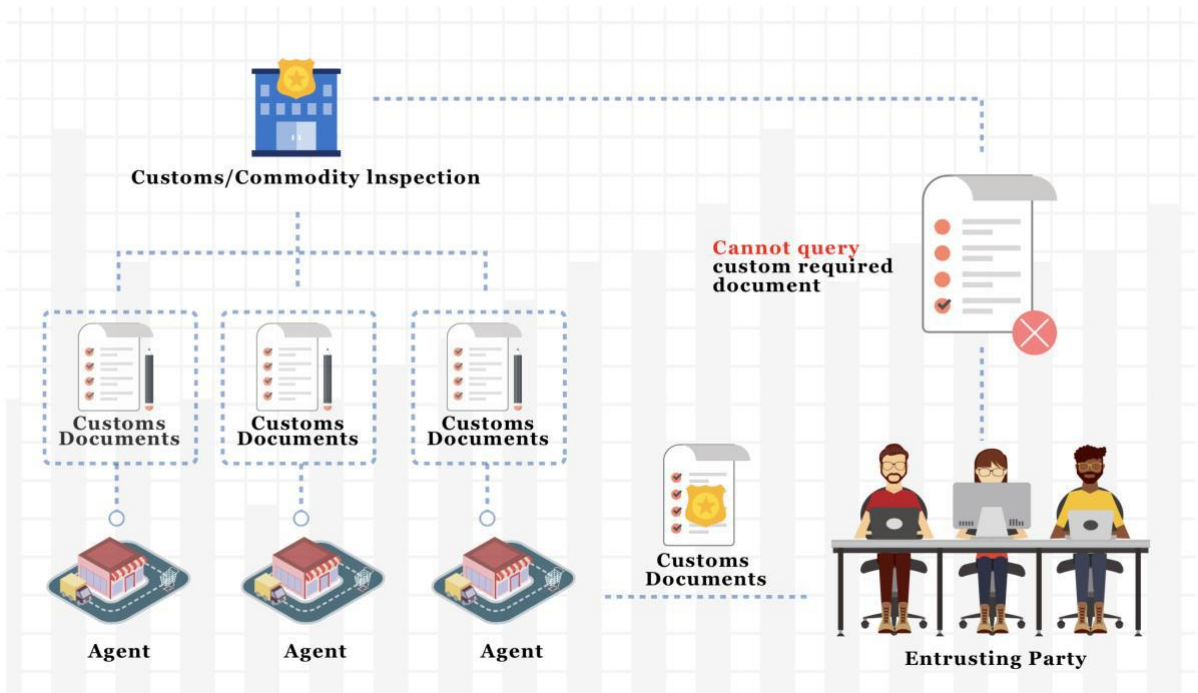

Figure 6.6.1 current system flows of customs/inspection

VeChainThor platform is providing a new collaborative government system to connect multiple different functional departments for data sharing and proof. Customs documents can be registered to VeChainThor Blockchain with a unified ID. This allows different departments to access, inquire and update the same document with appropriate authorizations and trust. This new enabled system flow will improve operational efficiency and cost saving.

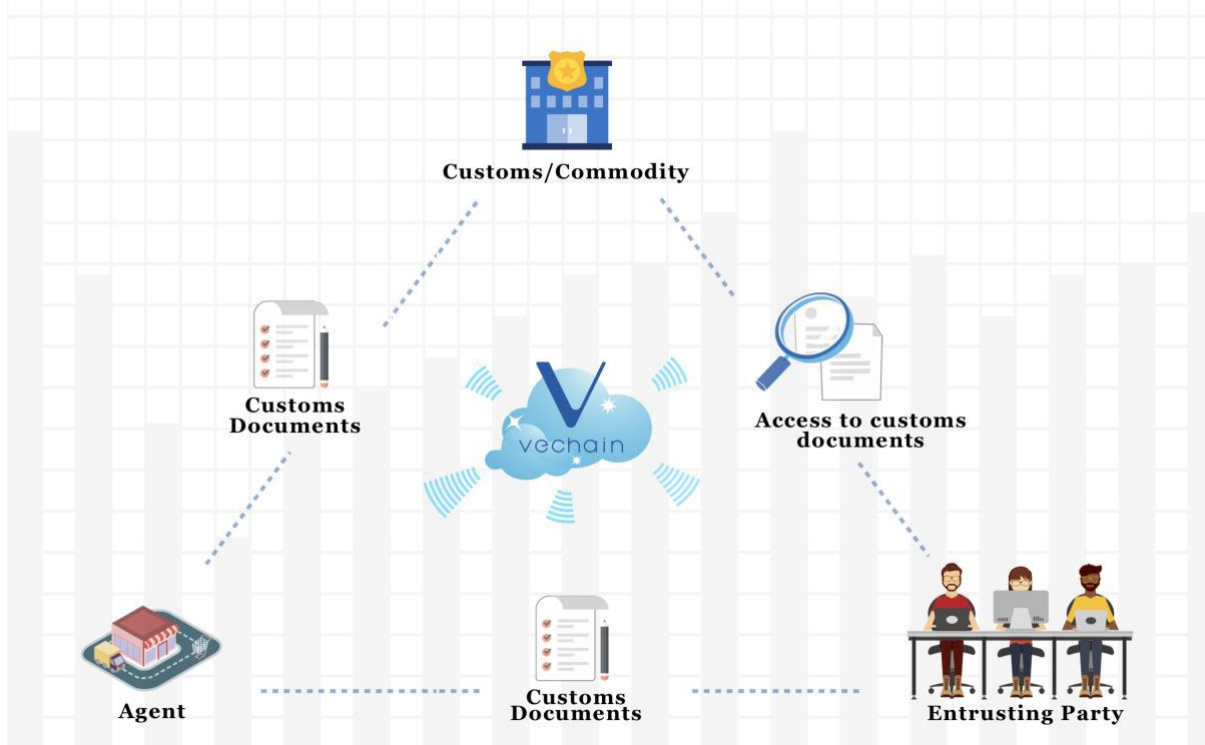

Figure 6.6.2 future Blockchain Government Application

Blockchain technology is of significant importance to governments. It represents open, public

and transparent administration regarding government information and operations. Furthermore, as the “coordinator” of the whole commercial environment, government can focus more on how blockchain can improve the efficiency of resource distribution, allocation and optimization, including across different industries.

## 6.7 This is just the beginning

The biggest challenge the VeChain team has been facing during the use cases development and implementation in the past two years is not the technical concerns, but the business consensus of how to achieve new business models. However, we have been through the worst part already. We greatly appreciate all our business and technical partners who dare to step into this field with us with great innovative spirit.

Despite all our accumulated experiences and solutions delivered, we still have a long way to go to make a bigger difference. We have been grateful to have a wonderful VeChain community with us for this journey together. Of our opportunities for projects and applications that are in the pipeline, more than 50% of them have come from the community. We wish to call for more pioneers to join us to develop more use cases and applications for the prosperity of the trust-free ecosystem on VeChainThor Blockchain.



## 7 VeChain Foundation Economy

The VeChain Foundation implements and sticks to the following principles for ecosystem development:

- 1) The VeChain Foundation serves the purposes of a non-profit organization;
- 2) Efficient and sustainable development; and
- 3) Open source and sharing.

From a financial perspective, the VeChain Foundation will seek a financial balance between sustainable operations and community development and expansion. In addition to the initial funding received during the token sale, the Foundation will be able to obtain digital asset funds through different operational activities in the ecosystem. Under the audit and supervision of our third-party trusted institution, any net profit will be ultimately distributed back to the community in transparent ways.

The VeChain Foundation has set up a full-time financial management team to maintain its financial activities and digital assets. The financial management team reports directly to the Steering Committee, and regularly prepares financial reports and disclosures for the Foundation, usually every quarter.

### 7.1 Funding Sources

The main income of the Foundation will be made up from two areas:

- 1) Non-operating income including the initial token sale funds and returns from digital assets;
- 2) Regular operating income, including research and development results, product sales, patent transfers or licensing, academic exchange and contribution, and so on.

The following is a detailed description of the main sources of income:

#### 7.1.1 Initial Funds and Token Release

VeChain has issued in total 1 billion ERC20 VeChain Tokens (VET) on Ethereum.

There are 132,837,366.56 ERC20 VET that have been refunded and destroyed / burned under the audit of our third-party trusted institution. The results have been disclosed in public and can be checked in Ethereum's blockchain explorer for the current ERC20 VET.

The current total supply of ERC20 VET is 867,126,344.66. After token split, the total supply of native VET will be 86,712,634,466.

The VET allocation plan is as follows:

<b>Ratio</b>	<b>Distribution Plan</b>	<b>Details</b>
41%	ERC20 VET Public Token Sale	The income of the VET crowdsale will be used for the operations of the VeChain Foundation, including development, marketing, finance and legal advisory.
9%	Private Investors	Private investors are very influential in the community and industry, and they will help for both technology and business development.
23%	Enterprise investors	'Enterprise investor' refers to an enterprise in VeChain's distributed business ecosystem or a service provider for these corporate customers or end users; these enterprise investors will use VET as a key development target in their business activities.
5%	Co-founders, development team	To be distributed to the founders and development team of VeChain as their reward.
12%	Continuous operation and technological development	To be reserved for various operating costs and development of VeChain.
10%	Business case development	To choose suitable industries, using VeChain technology for strategic deployment in the industry, project support and token replacement.

### 7.1.2 Digital assets investment

During ongoing operations, VeChain Foundation allocate about 5% to 10% of the funds or digital assets to setup a VeChain Incubation Program along with other venture capital funds such as Fenbushi Capital, Future Capital, and other reputable crypto funds which are continuously increasing to support blockchain projects, which are willing to develop business applications on VeChain or future technical or business partnerships.

### 7.1.3 Professional Services

In the process of building the ecosystem, the VeChain Foundation serves as a public service provider of the VeChainThor Blockchain and receives a certain amount of digital assets or funds. For example, the VeChain Foundation can provide a professional service to traditional enterprises to ease and simplify the process of developing, building, maintaining and generally transforming their new business by using VeChainThor Blockchain. In return, the VeChain Foundation will receive a service fee in the form of digital assets, i.e. VET.

## 7.2 Fund Budgeting

As mentioned above, the VeChain Foundation's budget mainly includes day-to-day operations, technology development & research, business development and investment. The main categories are shown in the following table:

Classification	Percentage	Content
Technology Development	50%	This mainly includes earnings for the technical team, recruitment of experts and developers, technical patent and protection of intellectual property rights
Business Development	35%	VeChain business engagement and development, knowledge exchange and sharing, regulation and compliance, alliance establishment and participation, etc.
Investment	10%	VeChain Incubation Program to support the other startups to build up business applications on VeChainThor Blockchain or for collaborative purposes
Daily Operation	5%	Daily administrative and operational tasks including renting offices, logistics management, transportation, financial and reporting, etc.

The following is the forecast for the next four years for the purpose of budget planning:

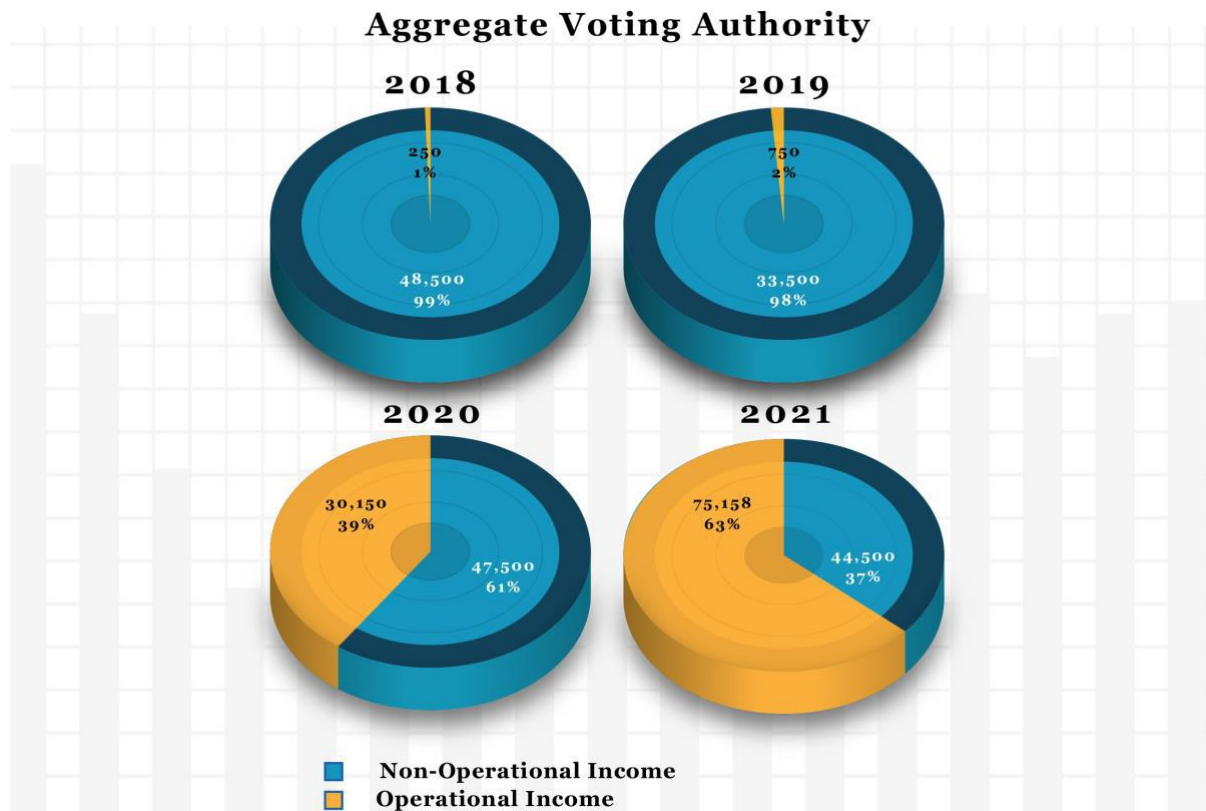

Figure 7.2.1 VeChain Foundation's 4 year annual revenue forecast (000 USD)

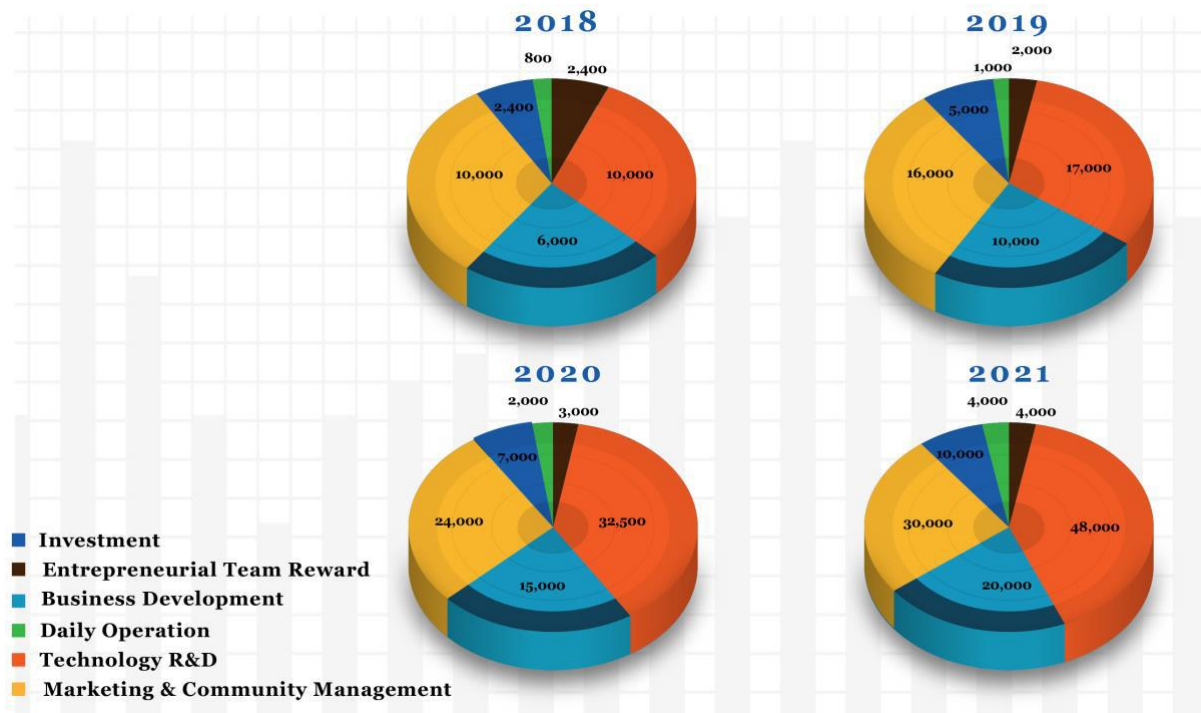

Figure 7.2.2 VeChain Foundation 4 year cost forecast (000 USD)



Figure 7.2.3 the VeChain Foundation's 4 year retained earnings forecast (000 USD)

To sum up, the VeChain Foundation has obtained initial funds through ICO activities, and will take about 4 years to achieve the following:

**Growth of the VeChain Foundation.** This includes headcount increasing to between 100 and 150 for both technical and business development, and business growth of 20 billion USD as “VeChain GDP” running on VeChainThor Blockchain.

**Focus on R&D and business development.** A significant part of the total budget will be allocated to both technical development and business development for the ecosystem growth.

**Drive value** The Foundation will not only consume initial ICO start-up funds to build up the ecosystem and create commercial value with the community, but additionally the Foundation has obtained and will obtain revenue by providing various blockchain services within the system. The VeChain Foundation is motivated to ensure that the gains will be balanced with the expenditure of continuous operations.

**Non-profit principle.** The VeChain Foundation promises not to distribute profits or dividends to the founder team, controllers or shareholders in the Foundation. The operating income, subtracted the operational expenditure, will all be allocated to the cause of the community and ecosystem development.

## 7.3 Fund Use Restriction

The use of funds is in line with the principles of openness and transparency. According to our distribution and budget principles, VeChain will set up a series of separate accounts and digital asset wallets to supervise the usage of digital assets. The use of funds will be directed to the development of VeChain ecosystem and improvement of blockchain technology and application. This information will be disclosed to community on a regular basis.

## 7.4 Financial Plan and Implementation Reports

Each quarter, the financial team will prepare its report including financial planning and a summary of financial performance over the last quarter. The report will be released to the public after approval from the leader of Financial Units of Operational Committee. The formation of financial reports will be submitted to the Steering Committee for approval.

## 7.5 Digital Asset Management

The digital assets belonging to VeChain Foundation are supervised by Steering Committee and managed by the full-time finance team under the leader of the Operational Committee who is appointed by Steering Committee.

The finance team has established a set of digital asset management policies and procedures to regulate the operations of the digital assets. The following key management principles are implemented:

- 1) Dedicated teams. A group of teams, not individual persons, are working together to operate, record and monitor use of digital assets. The digital assets belong to the VeChain Foundation so no individual, even the members from the Steering Committee have access to the digital assets. That is to say, the private keys of the digital assets wallets are stored in encrypted tokens. The passwords for the tokens are set by the authorized steering committee members, however the tokens are physically stored in the bank vault. The vault can only be accessed by a combination of three authorized persons, who have no access to the passwords for the tokens.
- 2) Segregation of duties. This involves two layers of segregation:
  - a. The approval and execution duties are segregated, i.e. the person who has approval rights cannot operate the digital assets wallet.
  - b. The accounting and operations are segregated, i.e. accounts and digital assets operations are assigned to different persons. Each transaction needs to be reconciled. The accounting books must be reconciled to the digital assets ledger on a periodical basis.
- 3) Improving asset security. This too involves two layers of security:
  - a. Asset wallet designation. The Foundation has allocated digital assets to different wallets. For daily operational use, the foundation has set up the hot wallet. For a large amount of funds, they have been stored in cold wallets which are stored in a secure vault.

- b. Balance of different assets. The Foundation evaluates the different values of digital assets, i.e. BTC, ETH or other tokens and adjust the portion of them on a periodical basis. It is to balance the liquidity of the tokens and in addition stabilize the value of digital assets.
- 4) Continuous monitoring. The monitoring mechanism is built to supervise the use of the digital assets. Any abnormal use of the assets will trigger an alarm so that an independent team will consider further investigation of such use.
- 5) Business Continuity Plan (BCP) and Disaster Recovery Plan (DRP). Formal digital asset based BCP and DRP (Crypto DRP, CDRP) has been established and approved by the Steering Committee. The plans include different measures to recover digital assets or restore digital asset wallets in various emergency circumstances. These circumstances include breakdown of the hot wallet, breakdown of devices or wallet hacking or attacks. A CDRP drill is performed every quarter.

Following the best practices of risk management and internal control, the Foundation has decided to adopt a multi-signature process to ensure the safety and accuracy of asset movement, after sufficient testing on multi-signature technology. Based on the principle of independence, VeChain Foundation applies a 4/7 multi-signature process for all of its significant wallets. Any new added signature or modification is subject to the approval of the Steering Committee.

The above digital asset management policies and procedures are reviewed and improved on a regular basis in consideration of new digital asset best practices. They will be approved by the Steering Committee and shared with the public.

## 7.6 Disclosure

Once a year, the VeChain Foundation will share the progress and status of the business and technical development, operations, and future plans with the community. For the financial situation of the Foundation, the public financial report will be drafted and shared quarterly, and the work of the annual audit will be disclosed.

The VeChain Foundation has established the Public Relations Committee, which serves as an external window for regular and irregular meetings, and will release important information to the public.

## 7.7 Legal affairs

The VeChain Foundation has commissioned a trusted third-party organization to set up a legal entity in Singapore. All operations are subject to local laws, regulations and regulatory requirements. If there is any requirement for legal advice such as business agreement, contracts, disputes and so on, any legal activity must be confirmed by local counsel.

## 7.8 Exemption clause

The VeChain Foundation insists on the nonprofit nature of operations along with the development of VeChain ecosystem. Whether or not they have obtained VeChain Tokens, users who participate in the VeChain community have the right to hold or give up VeChain Tokens. Holding VeChain Tokens guarantees the holder's right to execute token transactions or smart contracts on the VeChainThor Blockchain platform. Investors or token holders should understand that within the scope of the law, the VeChain Foundation does not make any expression or implication of warranties and/or benefits. In addition, investors should understand that the VeChain Foundation is not responsible for any type of refund after tokens are issued/transferred.

## 7.9 Settlement of dispute clause

When a dispute arises, the parties shall drive to settle it by negotiation and come to an agreement. If the dispute cannot be solved by negotiation, it will apply the local jurisdiction where VeChain Foundation is registered, n.b. Singapore.



## 8 Introduction of the Team and Team Members

The team members of VeChain are from different industries and countries with different experiences, expertise, and backgrounds, but follow the same dream and passion. The composition of the team is well balanced with business, technology, operations and support which are all significant factors to success.



### **Scott Brisbin , General Counsel**

Scott is a well-known lawyer from the United States. His clients include the Rolling Stones and lead singer Mick Jagger, Disney, MGM and so on.

He graduated from the University of California, Los Angeles in 1978. He joined the law firm MSK, and became a partner in 1989. In the company's legal affairs and patent maintenance, he has absolute authority. Scott joined VeChain in 2016 and worked on VeChain's legal security, organizational structure and property.



### **Cissy Chen, HR and Admin Manager**

Cissy has over 6 years' experience in human resources management and worked for sub-brands of Unilever before joining VeChain in 2015.

She is in charge of human resources management, recruitment, staff training, compensation and establishment of other related strategies and policies.



### **Kevin Feng, COO**

Kevin worked in the Cybersecurity and Privacy practice of the PwC Shanghai and New York offices for over 12 years. He was the driver of blockchain services in PwC China.

Kevin joined VeChain in 2018 as COO, responsible for operations, security and privacy.

He is a Certified Information System Security Professional (CISSP) and Certified Cloud Security Professional (CCSP).



**Richard Fu, Business Development and Relationship Director**

Richard has over 20 years' working experience in multi-national enterprises such as the Shangri-La Group and LVMH specializing in sales and marketing.



**Jerome Grilleres, VeChain Europe GM**

Jerome holds an MBA from London Business School and an MSc in Computer Science. He joined from Barclays France and has 8 years' experience in business strategy and development in retail banking and 6 years in developing real time trading applications in investment banks.

Jerome joined VeChain in 2017 as Business Director of Europe.

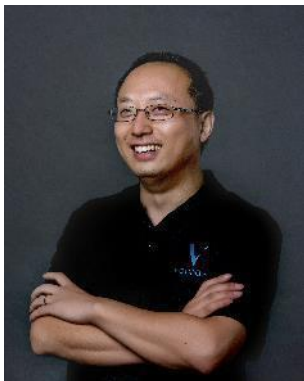

**Jianliang Gu, CTO**

Jianliang graduated from Shanghai University with a master's degree majoring in Cybernetics. He was working at TCL Communication Technology as Technical Director. He has more than 16 years' experience in both hardware and software of embedded system development and management.

He joined VeChain in 2017 and is committed to marrying IoT and Blockchain.

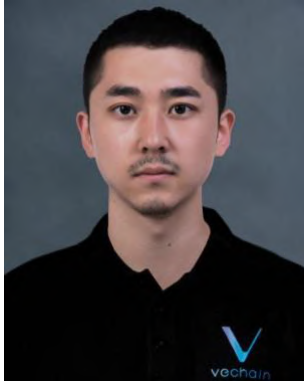

### **Noah Huo, CMO**

Noah Huo has over 5 years experiences of consulting and assurance services in FinTech, cybersecurity, internal control and blockchain technology. Before Noah joined PwC Shanghai in 2014 he had worked at National Australia Bank in the financial crime detection and prevention team. Besides his extensive experience in cybersecurity and internal control, Noah has played a critical role in the blockchain development team within PwC CN/HK region. In February 2018, Noah joined VeChain and is in charge of PR and community management.



### **Lingbo Li, Risk Controller**

Lingbo graduated from the Chinese Academy of Sciences with master's degree in Finance Engineering. She has over 11 years' experience in credit risk management and asset management. She joined VeChain in 2016 and is responsible for digital asset management and related risk control.



### **Tony Li, Blockchain Core Developer**

Tony majored in Information Security. He has 5 years' experience of software development and project management. He has taken part in numerous projects, including in the financial industry, insurance industry, luxury industry and automotive industry.

He has been interested in Bitcoin and blockchain technology since 2014, and has two years' experience of blockchain product development.



### **Sunny Lu, Co-founder & CEO**

Sunny graduated from Shanghai Jiao Tong University, majored in Electronics and Communication Engineering. He has served as an IT Executive in Fortune 500 companies over 13 years, and was the former CIO of LV China.

He started the VeChain project in 2015, and is committed to blockchain technology and business implementation.



### **Sarah Nabaa, VeChain Singapore GM**

Prior to joining VeChain in 2017, Sarah's background was in business development. After 3 years of proprietary trading, she bootstrapped and sold her e-commerce business and began consulting startups and SMEs on their digital strategies and transformation. She graduated from NTU with a Bachelors in Electrical and Electronic Engineering.



### **Bin Qian , Chief Blockchain Developer**

Bin has over 10 years' experience in the mobile application development industry, specializing in developing Internet applications-based real-time communication systems. He is a P2P network technology expert.

He joined VeChain in 2016 and is in charge of blockchain development.



### **Chin Qian, Channel and Sales Director**

Chin worked for HP from 2004 to 2016 and has accumulated rich experience in marketing and project management.

He joined VeChain in 2017 as director of business partner recruitment and management.



### **Cary Sheng, Financial Director**

Cary has worked in PwC as a manager for over 7 years. Her experience includes internal audit and cyber security assessments.

She has been involved in the blockchain industry from 2016 and designed an ICO assessment system and a cryptocurrency management system for enterprises. She joined VeChain in 2018 as Financial Director.



### **Jack Wu, Product and Project Manager**

Jack graduated from St. John's University (New York). He has over 3 years' iOS development and project management experience. He has taken part in numerous projects across government agencies, the luxury goods industry and the automotive industry. He joined VeChain in 2016 as Blockchain Project Manager.



### **Jay Zhang, Co-founder & CFO**

Jay has worked for PwC and Deloitte as senior manager over 14 years.

He joined VeChain in 2015 as the leader of the blockchain governance framework design and digital asset management framework establishment.



### **Edison Zhang, Product Director**

Edison graduated from ECNU with a master's degree, majoring in software engineering.

He has over 7 years' experience in product design and operation, and has led teams launching several successful products in mobile internet, IoT and Fintech fields. He co-founded 2 startup companies, has over 3 years' business management experience. He joined VeChain in 2017 as Product Director.



### **Peter Zhou, Chief Scientist**

Dr. Peter Zhou obtained his Ph.D degree in Computer Science from the University of Southampton. He was involved in projects funded by the European Commission and the Academy of Finland when working as a postdoctoral researcher at the University of Kent, UK as well as a senior research scientist at the University of Oulu, Finland. He has more than ten years of scientific research experience and published papers in top-tier international journals and conferences.

## Appendix A: Independence without association with stakeholders

This standard applies to independent members of the Board of Steering Committee and Advisory Board.

A member who satisfies the independence requirements of the applicable listing standards and meets all of the following categorical standards shall be presumed to be "independent":

- 1) Neither the member nor any of his or her immediate family members serve as a partner, significant shareholder or executive officer of any stakeholder of the Foundation.
- 2) Neither the member nor any of his or her immediate family is a significant VET holder. For purposes of this categorical standard, a VET holder shall be considered significant.
- 3) Neither the member nor any of his or her immediate family serves as an executive officer for the Foundation.
- 4) For purposes of these independence standards, an "immediate family member" includes a person's spouse, parents, children, siblings, mothers and fathers-in-law, sons and daughters-in-law, brothers and sisters-in-law, and anyone (other than domestic employees) who shares that person's home.

In addition to the above, the Board will broadly consider all relevant facts and circumstances when assessing director independence.



## Appendix B: Members of the first Board of Steering Committee and Advisory Board

### Members of Steering Committee and the associated stakeholders:

#### Head of Regulation Committee – CY Cheung (PwC Cybersecurity and Fintech Partner)

Chun Yin Cheung is a partner in PwC China's Risk Assurance Practice, based in the Shanghai office, having worked at PwC for over 14 years.

Mr. Cheung is an information security expert, with extensive experience in security assessment and regulatory compliance related advisory for financial service institutions in China and Hong Kong.

Mr. Cheung was educated at the Hong Kong University of Science and Technology and achieved a Bachelor of Business Administration (B.B.A.) in Information Technology

#### Head of Public Relation Committee - George Kang (CEO Greater China Region, DNV GL Assurance)

George Kang has worked for one of the biggest state-owned automotive design and manufacturing companies - SAIC Motor - before he joined DNV GL in 1999.

George has accumulated extensive experience in supply chain management, product assurance with a particular strategic focus on the food and beverage, healthcare, and automotive and aerospace sectors.

George was graduated from Shanghai Jiaotong University with a bachelor degree in Engineering and EMBA from Xiamen University.

#### Head of Operation - Jay Zhang (CFO / CoFounder VeChain)

Jay has worked at two of the 'Big 4' accountancy firms - PwC and Deloitte - and joined VeChain as leader of their blockchain governance framework design and digital asset management framework.

Jay has 14 years' experience in IT assurance and advisory services. Jay's major areas of expertise and experience include IT general controls, IT security, IT governance and risk management, and system application controls.

Jay was educated at Shanghai Jiaotong University and studied Electrical and Electronic Engineering

#### Head of Compensation and Nomination Committee - Margret Rui Zhu (Assistant Professor City University of Hong Kong)

Professor Zhu received her BA from Fudan University, China, MA in Economics from Indiana University USA and PhD in Finance from University of Texas at Austin USA. Professor Zhu is currently interested in corporate finance, corporate risk management and the interaction of capital markets and product markets.

#### Head of Technical Committee - Peter Zhou (Chief Scientist / VeChain Partner)

Dr. Zhou obtained a Ph.D in Computer Sciences from the University of Southampton and serves as VeChain's Research and Development Director. He has been involved in projects funded by the European Commission and Academy of Finland whilst working as a postdoctoral researcher for the University of Kent in the UK. He has been published in numerous international scientific research journals.

#### In Charge of VeChain Business Development Related Affairs - Renato Grottola (Global Digital



Transformation Director, DNV GL Assurance)

Renato is an experienced global Director with a strong track record of working in the advisory industry, skilled in strategic planning, mergers and acquisitions, business development and management of complex international operations. Renato has been working on a blockchain backed project to introduce ship certifications to a private blockchain.

General Secretary of the Foundation - Sunny Lu (CEO, VeChain Co-Founder)

Sunny Lu, the Project Lead for VeChain, has a wealth of experience in IT and Information Security across luxury retail brands, with his most recent role prior to co-founding VeChain being CIO, IS&T Director for Louis Vuitton China.

Part of the LVMH Group, other famous brands across the portfolio include luxury fashion brands Givenchy and Christian Dior, alongside champagne brands Moet et Chandon, Veuve Clicquot and Dom Perignon.

Sunny was educated at Shanghai Jiao Tong University and studied Electronics and Communication Engineering

**Nominated Members of Advisory Board and the associated entities:**

Jim Breyer - Founder and CEO of Breyer Capital

Jim has invested in over 40 companies that have gone public or completed a merger, with some of these investments, including Facebook, earning over 100 times cost and many others over 25 times cost.

Bo Shen - General partner of FENBUSHI Capital

Bo cofounded Bitshares, Zcash and other blockchain projects. He is a veteran of the traditional financial industry, accumulating 12 years of senior management in brokerages, hedge funds and investment banks.

Daniel Kelman - General Counsel of GSR and Bitcoin.com

Daniel represented the interests of creditors who lost funds in the Mt Gox hacking scandal. He is a co-founder of BitOcean Japan, a cryptocurrency exchange which will be licensed by the Japanese regulator FSA.

James Gong - CEO of ChainB.com

ChainB is the most influential professional blockchain and cryptocurrency media in China.

Roland Sun - Partner of a full-service Chinese law firm named Broad&Bright

Roland has rich experience in providing law consultancy services in cryptocurrency, blockchain, banking and trusts.

Nan Ning - CEO of BitOcean

BitOcean is a cryptocurrency trading service provider which has been licensed by Japanese regulator FSA in December 2017.

## Appendix C: References

- [1] V. Buterin. A next generation smart contract & decentralized application platform (Ethereum white paper), 2014.
- [2] G Wood. Ethereum: A secure decentralised generalised transaction ledger (Ethereum yellow paper), 2014.
- [3] S. Nakamoto. Bitcoin: a peer-to-peer electronic cash system, 2008.
- [4] POA Network. Proof of Authority: consensus model with identity at stake, Medium (<https://medium.com/>), 2017.
- [5] M. Castro and B. Liskov. Practical Byzantine fault tolerance, in the Proceedings of the Third Symposium on Operating Systems and Implementation, 1999.